



THE BRAVE INSPIRE

General Catalogue
2023

Index

Sanremo	_02
—	
Coffee Machines	_04
Opera 2.0	_06
Café Racer	_16
F18 MB	_26
F18 SB	_30
Verona RS	_34
Verona	_38
Napoli	_40
Torino	_42
Zoe Competition	_44
Zoe	_46
Cube	_48
You	_52
—	
Grinders	_56
X-One	_58
On demand	_62
AllGround	_64

THE BRAVE INSPIRE

PIONEERS OF A NEW VISION



A broad vision. A horizon defined by a high and ambitious goal, to be contemplated and then achieved, to be admired and eventually conquered.

Be inspired, take a deep breath then go: start your adventure.

Because courage is not the absence of fear, but the ability to conquer it.



SANREMO
COFFEEMACHINES

made in italy

SANREMO, MORE THAN A COMPANY

A benchmark for innovation and excellence in espresso coffee machines production Made in Italy; an inspirational brand for coffee lovers who celebrate the art of coffee extraction.

This is Sanremo: A fusion of a strong production tradition and ambitious dreams. A winning combination that has given

the company international recognition and is now a point of reference in the coffee machine sector.

Our production department is second to none, our technological know-how, mixed with quality materials, workmanship and creativity.

An international research & development team, trained by the best in the coffee industry united with the same fighting spirit which Sanremo machines express.

Coffee Machines



Opera 2.0



Opera. The full story
Watch the video



RoHS

Versions

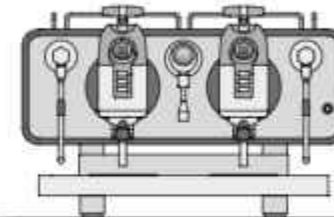

31" / 786 mm

2 group OP

- 2 steam taps
- 1 water tap
- 1 one-cup filter holder
- 2 two-cup filter holders

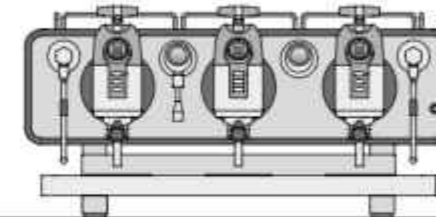

41" / 1040 mm

3 group OP

- 2 steam taps
- 1 water tap
- 1 one-cup filter holder
- 3 two-cup filter holders

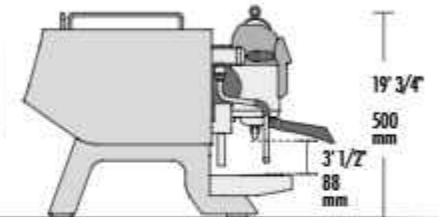

19" 3/4" / 507 mm
25" 2/3" / 653 mm



TALL VERSION

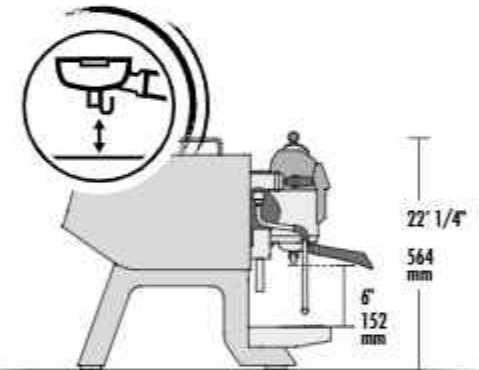

22" 1/4"
564 mm

MULTI-BOILER SYSTEM

High accuracy thermal stability thanks to the Sanremo multiboiler system with sophisticated electronic boards that continuously control temperature throughout all phases of extraction. Steam and coffee circuits work totally independent to maximize performance in every working condition (also under high workload).

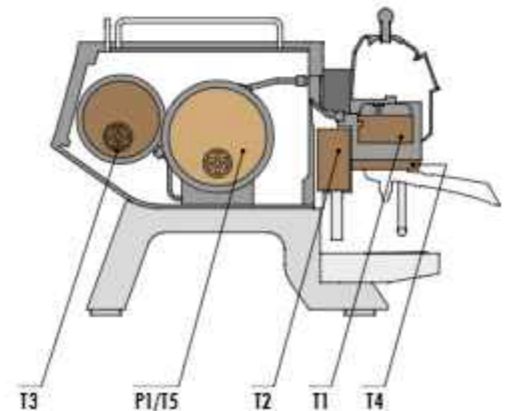

T3 P1/T5 T2 T1 T4



Technical data		2 group	3 group
voltage	V	220-240 1N / 380-415 3N	
max input boiler/steam boiler's resistor power	kW	7.7 / 3.5	8.3 / 3.5
		8.5 / 4.5	9.1 / 4.5
steam boiler services	h	8	10
external pump power	kW	0.15	0.15
preheating boiler capacity	h	2.8	2.8
preheating boiler resistance power	kW	1.5	1.5
cup-heater power	kW	0.20	0.25
units boiler capacity	h	1.0	1.5
units boiler resistance power	kW	1.6	2.4
net weight	lb / kg	200 / 91	249 / 113
gross weight (with shipping crate)	lb / kg	308 / 140	375 / 170.5

The Revolution

Be in control, express yourself

DOUBLE SELECTION BUTTONS

Easy-touch setting with 6 different profiles for individual groups

SMART LEVER

Coffee doses fast manual selection



CDS SYSTEM

Maximum precision and full control on the three phases of coffee extraction



POWER DRY STEAM

Low additional liquid during the milk steaming



GEAR PUMP PERFORMANCE

High and constant pressure in all conditions

EVERYTHING UNDER CONTROL

System digital display to provide visibility of all working parameters



HEART OF STEEL

For maximum thermal stability:

- Groups in AISI 316L weight 22 lb / 10 kg each
- Filter holders AISI 316
- Boilers AISI 316

WI-FI CONNECTION



EASY APP

Tablet or smartphone barista's Webapp for setting parameters



Opera. The Revolution
Link to the website

Characteristics



AISI 316L STEEL GROUPS WITH 22 lb / 10 kg PURE STEEL
Exclusive Sanremo design ensure exceptional thermal stability and maximum resistance to oxidation and lime scale.



AISI 316 STAINLESS STEEL FILTER HOLDER WITH "COMPETITION FILTER"
Exclusive Sanremo design, with shape and volume designed to capture the best coffee aromas and fragrances.



AISI 316L STAINLESS STEEL FREE MOTION STEAM TAPS
Flexible control system for producing and dispensing steam.



AISI 316L STAINLESS STEEL STEAM WAND "COOL TOUCH"
Anti-burning feature even in conditions of prolonged use, fitted with "Latte Art" high-performance steam terminals.



CONTROL COFFEE DELIVERY SYSTEM (CDS)
Three phases extraction parameters full control (pre-infusion, infusion, post-infusion).



INDEPENDENT ADJUSTMENT OF THE PID INFUSION WATER TEMPERATURE
Precision setting (gradient $\pm 0.1^\circ\text{C}$ with measured constancy lower than 0.2°C).



INFUSION WATER DISPLAY
Indicates tea and herbal teas water brewing temperature. (In the two group it is shown with the steam boiler display)



STEAM BOILER DISPLAY
Indicates steam boiler temperature and pressure. (In the two group Opera it is shown with the infusion water display)



COFFEE UNIT SINGLE DISPLAY
Controls of all coffee extraction parameters.



MACHINE'S PROGRAMMING PARAMETERS DISPLAY
The internal display is a handy programming interface for the maintenance technician.



MIXED INFUSION HOT WATER FOR TEA AND HERBAL TEAS
Instantaneous mixing of fresh water and steam for a better chemical and organoleptic quality.



GEAR PUMPS
Dedicated to each individual group, allow to change the pressure during infusion.



STEAM CONTROL ADJUSTABLE ELECTRONIC PRESSURE SWITCH
Sensor with 0.02 bar precision that allows the chosen pressure and steam in the boiler to be kept constant in all conditions of use.



PROGRAMMABLE CUP WARMER TEMPERATURE
Allows the cups to be kept at the optimum temperature in the most different climatic conditions.



EASY SERVICE
Fast access to the internal parts for quick and easy technical service.



AUTO-DIAGNOSIS, STATISTICAL DATA, SCHEDULED MAINTENANCE
Maintenance can be scheduled according to litres or number of coffees dispensed.



AUTO-ON, AUTO-OFF AND DAY-OFF FUNCTION
Programmable on-off timer for each day and/or daily timetables.



AUTOMATIC CLEANING CYCLE
Process for coffee groups cleaning.



ENERGY SAVING SYSTEM
Component insulation and smart electronics for maximum energy efficiency.



GROUP FLUSHING
With a simple pressure of the button a small quantity of water is dispensed to allow the group to be always clean.

Optional



STAINLESS STEEL NAKED PORTAFILTERS



TALL VERSION

HIGH POWER STEAMER TERMINAL (bigger holes diameter)



ENHANCED RESISTANCE

EXTERNAL VOLUMETRIC PUMP

Standard models

wide range of models



✓ **Opera Steel**
Standard back panel: [BP1]

OPERA 2.0 THE REVOLUTION



✓ **Opera Black**
Standard back panel: [BP5]



Choose the panel

to suit your style



BP1 Etched crystal / backlight



BP2 Painted wood



BP5 Black / backlight



Back panel of each version can be customized, with finishes that complement your style and needs.



✓ **Opera White**
Standard back panel: [BP2]



Everything in an App

app dedicated to parameter settings for tablet

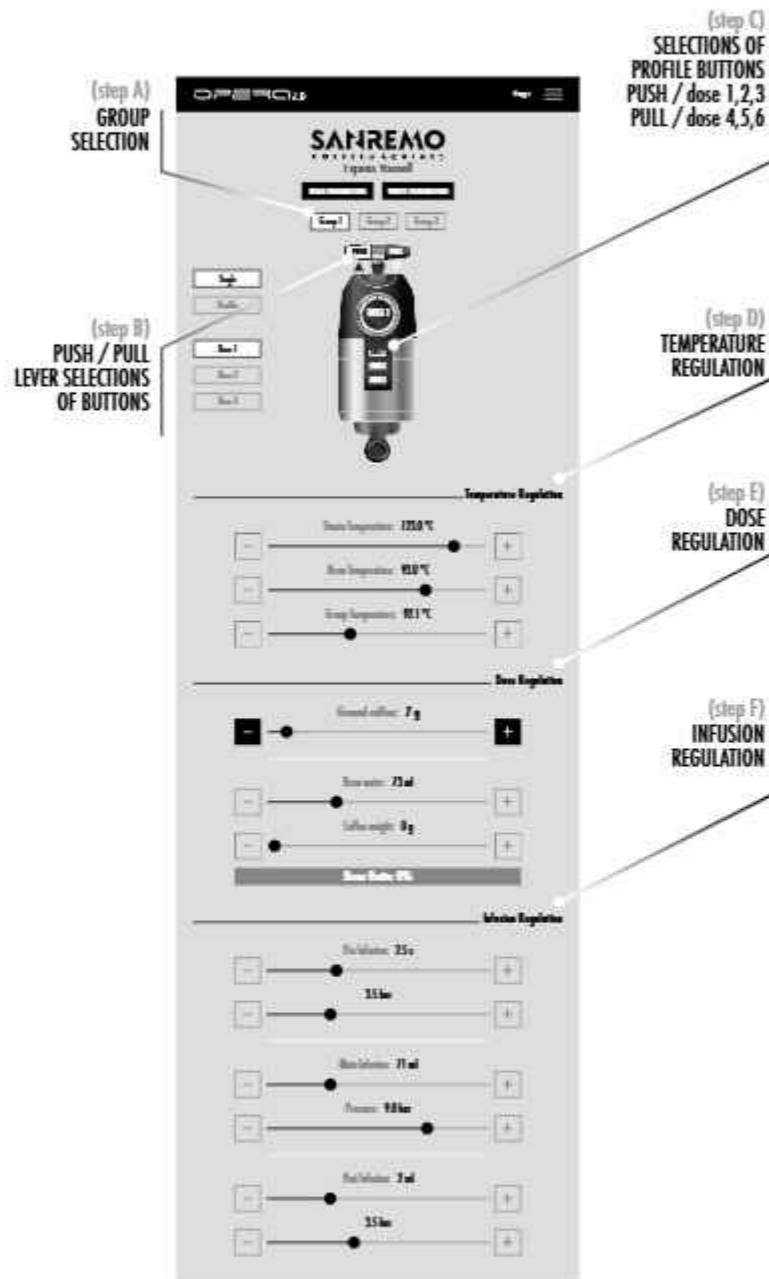

For each group it is possible to set:

Temperature

- water temperature T2
- group temperature T3
- steam temperature T5 (unique boiler for all groups)

Dose

- weight of ground coffee
- water dose
- pump pressure
- coffee weight

Infusion

- timing
- pump pressure
- amount of water

With the interface "Express yourself", the barista has total control of the extraction phase of his coffee and can manage each dispensing parameter according to his experience and professionalism.

To configure and set all the parameters of the machine, a specific App has been designed, which runs on tablet.

The application "Express yourself" utilizes a graphic interface, it is both user friendly and intuitive. This interface allows the user to set each groups relative parameters accurately for the perfect extraction.

Upon choosing the group (step A) and assigned a configured profile (step B,C) will define the general parameters of extraction: temperature and doses (step D,E). At the end it is possible to adjust the parameters relative of the 3 extraction's phases: pre-infusion, main infusion, post-infusion (step F).



PRE-INFUSION



INFUSION

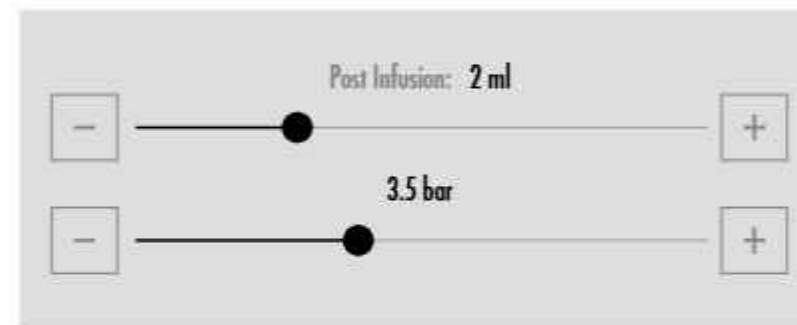

POST-INFUSION



(step F)

Adjust the 3 extractions phases

This operation is simplified by the App. Everytime the user modify one of these parameter the software update automatically. What was set prior to the modification.



CONFIGURATIONS

- STANDARD
- STRONG
- BALANCED
- SWEET & LIGHT
- ... N (set by the user)
- ... N (set by the user)

It is possible to save and recall new configurations set by the user or the default ones, specifically designed to allow even the less experienced bartenders to obtain immediately excellent results in the cup.

Clicking in "save new configuration" you can save your perfect espresso dispensing menu and transfer it into another machine.

Opera wi-fi

simplify things



From today the Opera 2.0 is easier to handle, thanks to the *Sanremo Cloud* and *Webapp Expressyourself* interface, for an even easier and interactive using experience.

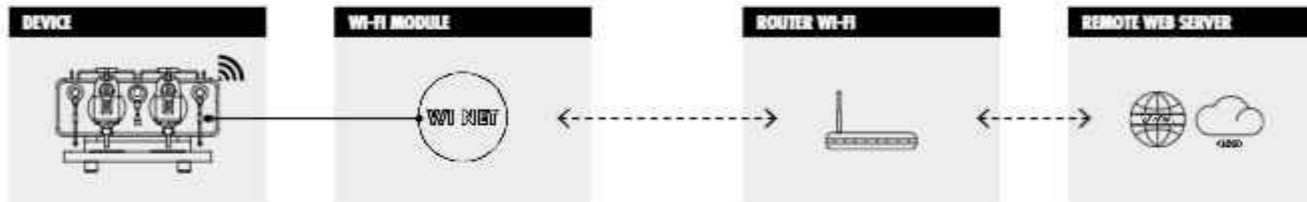

- Handling through Sanremo app, from smartphone, tablet, or pc, of all configuration parameters of the machine, without the need for physically being in front of it.
- Possibility of connecting multiple machines simultaneously for sharing, modifying, and setting of recipes and configurations.
- Simultaneous monitoring and handling of multiple machines by the same owner (e.g.: franchising in different locations).
- Statistical analysis of consumption, distribution, maintenance, configuration for all connected machines.
- Remote maintenance by the technician for updating, verification of the correct settings and parameters control.

- BARISTA
- MANAGER
- MAINTENANCE SERVICE
- MANUFACTURER
- SANREMO CLOUD
- INTERNET GLOBAL NETWORK
- LOCAL WI-FI NETWORK

INTRANET (WI-FI LOCAL NET)

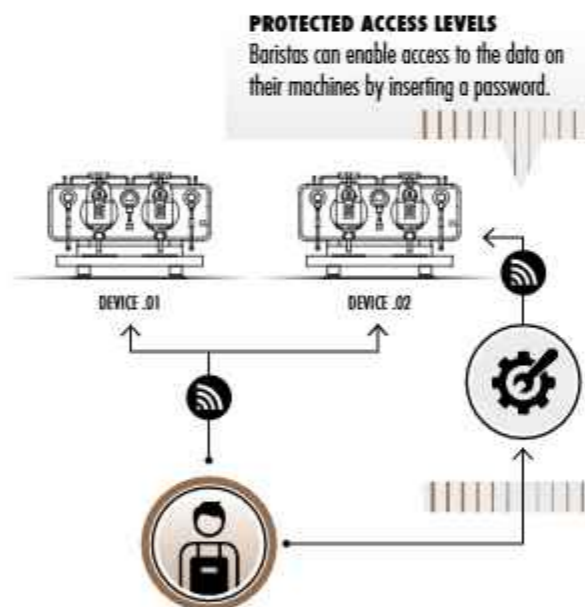

- PLUS+ (USING THE LOCAL WI-FI NETWORK)**
- Reading and changing machine settings and parameters
 - Consumptions analysis for a better stock management
 - Meters reading of the coffee dispensed
 - Saving, restoring and sharing of settings (recipes) on your machines

Data exchange can only be effective in the wi-fi range.

INTERNET (GLOBAL NET) / SANREMO CLOUD

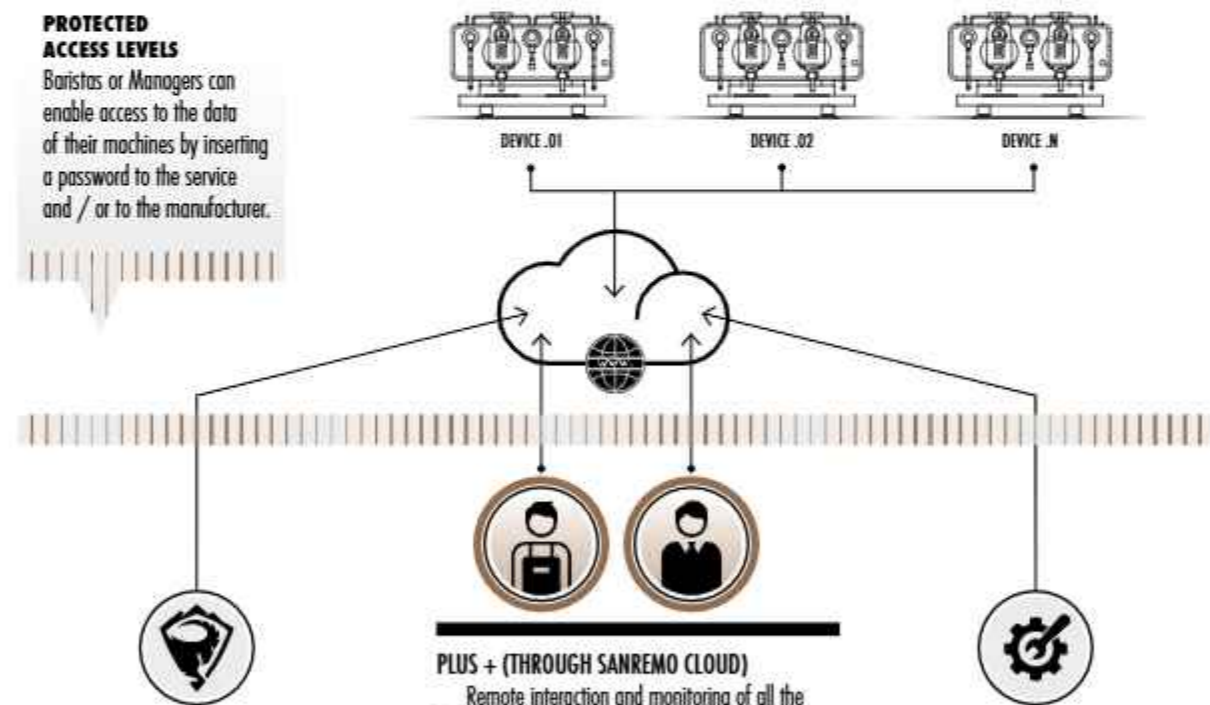

- PLUS+ (ENABLING THE MANUFACTURER)**
- Sending of App updates to the machines
 - Sending new settings (recipes)
 - Clearer and faster data collection aimed to resolve any technical/constructive problems
 - Useful information for the improvement and evolution of the product
 - Direct and continuous contact with the manufacturer

- PLUS+ (THROUGH SANREMO CLOUD)**
- Remote interaction and monitoring of all the functions and performances of the machine
 - Reading and changing of the machine settings
 - Display of historical usage data
 - Consumptions analysis for a better stock management
 - Meters reading of the coffee dispensed
 - Saving, restoring and sharing of settings (recipes) on your machines

- PLUS+ (ENABLING THE SERVICE)**
- Immediate report of anomalies
 - Diagnosis and possible remote troubleshooting
 - Reduction of machine downtime
 - Logistic planning and organization of maintenance interventions

Café Racer



RoHS

Versions

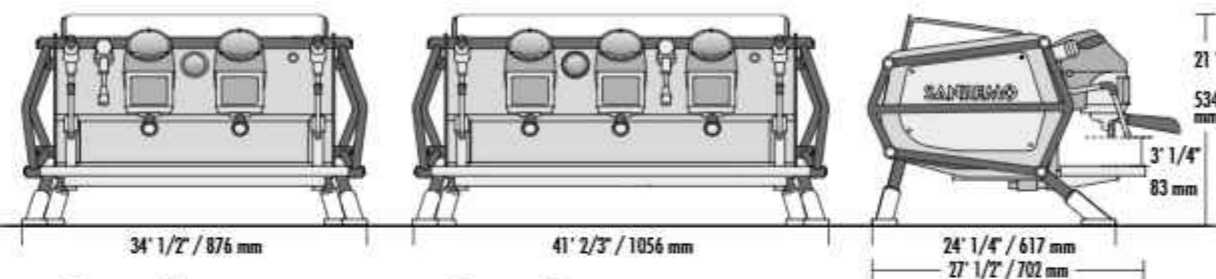

2 group CR
 2 steam taps
 1 water tap
 1 one-cup filter holder
 2 two-cup filter holders

3 group CR
 2 steam taps
 1 water tap
 1 one-cup filter holder
 3 two-cup filter holders



CE

Technical data

		2 group	3 group
voltage	V	220-240 1N / 380-415 3N	
max input boiler/steam boiler's resistor power	kW	6.9 / 3.5	8.1 / 3.5
		7.6 / 4.5	8.4 / 4.5
steam boiler capacity	lt	8	10
external pump power	kW	0.160	0.160
preheating boiler capacity	lt	1.0	1.5
preheating boiler resistance power	kW	1.0	1.5
cup-heater power	kW	0.16	0.20
units boiler capacity	lt	1.0	1.5
units boiler resistance power	kW	1.6	2.4
net weight	lb / kg	214 / 97	265 / 120
gross weight (with shipping crate)	lb / kg	333 / 151	388 / 176

MULTIBOILER SYSTEM

Sanremo Café Racer multiboiler system ensures a new level of thermal precision thanks to the 4 points of temperature PID control.

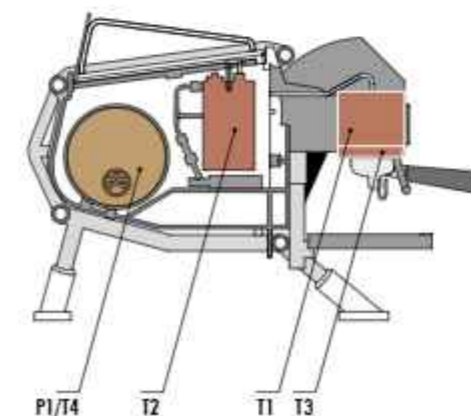

Take a ride, explore it's soul



ENERGY SAVING SYSTEM

Component insulation and smart electronics for maximum energy efficiency



VOLUMETRIC PUMP PERFORMANCE

The unique 300 l/h pump guarantees constant pressure in all conditions of machine use

HIGH PERFORMANCE FLOWMETER VOLUMETRICS

For an accurate and precise coffee dose in the cup



POWER DRY STEAM

Low additional liquid during the milk steaming



EASY SERVICE

Fast access to the internal parts for quick and easy technical service



Smart-touch setting of the individual groups

EVERYTHING UNDER CONTROL

System digital display to provide visibility of all working parameters



HEART OF STEEL

For maximum thermal stability:

- Groups in AISI 316L, weight 17.6 lb / 8 kg each
- Portafilters AISI 316
- Boilers AISI 316

ADJUSTABLE HEIGHT WORK SURFACE

Innovative Sanremo "All in one" suspension system that allows cups of different shapes and heights (adjustable from 3' 2/4" to 5' 3/4" / from 85 to 150 mm)



SOFT PRE-INFUSION

Flowactive System: for precise control of the water flow and pre-infusion time



Café Racer, born to run
Link to the website

Characteristics

- AISI 316L STEEL GROUPS WITH 17.6 lb / 8 kg PURE STEEL**
Exclusive Sanremo design ensure exceptional thermal stability and maximum resistance to oxidation and lime scale.
- AISI 316 STAINLESS STEEL FILTER HODER WITH "COMPETITION FILTER"**
Exclusive Sanremo design, with shape and volume designed to capture the best coffee aromas and fragrances.
- AISI 316L STAINLESS STEEL FREE MOTION STEAM TAPS**
Flexible control system for producing and dispensing steam.



AISI 316L STAINLESS STEEL STEAM WAND "COOL TOUCH"
Anti-burning feature even in conditions of prolonged use, fitted with "Latté Art" high-performance steam terminals.



PROGRAMMABLE ELECTRONIC PRE-INFUSION
Allows control with 0.1 second tolerance of the flow of water that wets the coffee bed, with programming of 4 different profiles for each group.



INDEPENDENT ADJUSTMENT OF THE PID INFUSION WATER TEMPERATURE
Precision setting (gradient $\pm 0.5^\circ\text{C}$ with measured constancy lower than 0.2°C).



SYSTEM DISPLAY
Visibility of all the machine functions: temperatures, pressures and levels.



COFFEE UNIT SINGLE DISPLAY
Control of all coffee extraction parameters.



MIXED INFUSION HOT WATER FOR TEA AND HERBAL TEAS
Instantaneous mixing of fresh water and steam for a better chemical and organoleptic quality.



HIGH PERFORMANCE VOLUMETRIC PUMP 300 l/h
Pressure stability also with prolonged and contemporary use of more than one group.



HIGH PERFORMANCE FLOWMETER VOLUMETRICS
For an accurate and precise coffee dose in the cup.



STEAM CONTROL ADJUSTABLE ELECTRONIC PRESSURE SWITCH
Sensor with 0.02 bar precision that allows the chosen pressure and steam in the boiler to be kept constant in all conditions of use.



PROGRAMMABLE CUP WARMER TEMPERATURE
Allows the cups to be kept at the optimum temperature in the most different climatic conditions.



ELECTRONIC AUTO-LEVEL
Through an electronic level probe the boiler is automatically filled and maintained to the right filling level.



LED LIGHTING OF THE WORK AREA
Allows efficient working in any condition of environmental lighting.



AUTO-DIAGNOSIS, STATISTICAL DATA, SCHEDULED MAINTENANCE
Maintenance can be scheduled according to litres or number of coffees dispensed.



AUTO-ON, AUTO-OFF AND DAY-OFF FUNCTION
Programmable on-off timer for each day and/or daily timetables.



AUTOMATIC CLEANING CYCLE
Process for coffee groups cleaning.



BOILER WATER REGENERATION
Ensures resetting of the optimum chemical characteristics of the water and correct mineralization.



GROUP FLUSHING
With a simple pressure of the button a small quantity of water is dispensed to allow the group to be always clean.

Other



STAINLESS STEEL NAKED FILTER HODERS



HIGH POWER STEAMER TERMINAL
(bigger holes diameter)



EXTERNAL VOLUMETRIC PUMP



ENHANCED RESISTANCE

NAKED

- ✓ Transparent side and back panels

Available in 2 finishes:
black and steel, 
both available with some components*
in black or red.

● ●
*rings, bolts, feet, boiler insulation



FREEDOM

- ✓ Coloured side and back panels with the rear-lit logo

Available in 2 finishes:
black and steel, 
both available with some components*
in black or red.

● ●
*rings, bolts, feet



CUSTOM

Welcome to the Custom world of the Cafe Racer, huge creative potential and expression through customization. Some versions have become real icons. Choose your style and create your own unique Cafe Racer.

Renegade



handmade finishes [

- Dark green
- Oxidized copper
- Brown leather
- Polished brass
- Oxidized brass



White & Wood Standard

CUSTOM

22



- Matt white**
- Natural oak**
- Stainless steel**
- Natural oak**

White & Wood Slim



Racing

CUSTOM

23



- Gloss red**
- Matt white**
- Carbon**
- Stainless steel**

Dolomiti



- Matt black**
 - Black steel**
 - Black leather**
 - Stainless steel**
- hand-sewn*

Black & White

CUSTOM



□ Matt white
● Stainless steel

Full White



F18 MB



RoHS

Versions

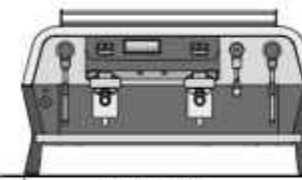

35' 1/2" / 901 mm

2 group

- 2 steam taps
- 1 water tap
- 1 one-cup filter holder
- 2 two-cup filter holders

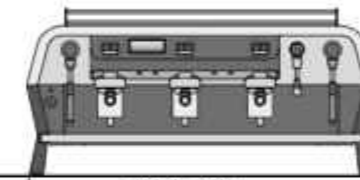

42' 1/4" / 1071 mm

3 group

- 2 steam taps
- 1 water tap
- 1 one-cup filter holder
- 3 two-cup filter holders

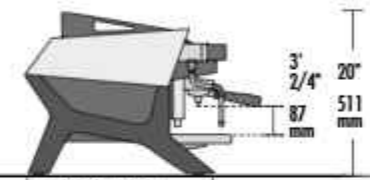

23' 1/4" / 589 mm
25' 1/2" / 647 mm

3' 2/4"
87 mm

20"
511 mm



5"
122 mm

20"
511 mm



TALL VERSION

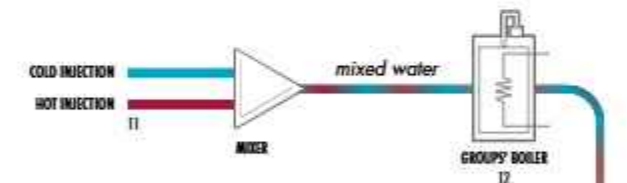

MULTI-BOILER SYSTEM

Each group has a dedicated boiler powered by preheated water thanks to the mixing of cold and hot water coming from the heat exchangers; the group is kept at the ideal temperature by a specific resistor, which ensure a perfect thermal regulation.



Technical data

		2 group	3 group
voltage	V	220-240 1N / 380-415 3N	
max input boiler/steam boiler's resistor power	kW	5.4 / 3.5	6.1 / 3.5
		6.3 / 4.5	7.2 / 4.5
		7.3 / 5.5	8.2 / 5.5
steam boiler capacity	lt	8.6	10
pump power	kW	0.15	0.15
boiler capacity	lt	1	1.5
boiler element power	kW	1	1.5
cup-heater power	kW	0.20	0.25
net weight	lb / kg	182 / 82.5	222.5 / 101
gross weight (with shipping crate)	lb / kg	241.5 / 109.5	278 / 126

Colours

	Matte black	RAL 9005
	White Matte black	RAL 9003 9005
	Blue Matte black	RAL 5024 9005



QUICK STEAM COUPLING

The completely new half-turn knob with **INTEGRATED PURGE** function, allows extreme precision limiting physical stress

REALTIME STABILITY GROUP

Exclusive Sanremo design that allows an accurate maintenance of the set temperature



REALTIME STABILITY

Constancy in the electronic controlled temperature ($\pm 0.2^\circ\text{C}$)

In flight stability
Ready to take off



ENERGY SAVING SYSTEM

Component insulation and smart electronics for maximum energy efficiency



STAINLESS STEEL "COLD TOUCH"

Anti-burning feature fitted with "Latte Art" high-performance steam terminals



DIE-CAST ALUMINIUM LEGS

Machine support made in die-cast aluminium



OPERATION ALARM MANAGEMENT

Dedicated menu for malfunction and alarm records



SOFT PRE-INFUSION

Flowactive System: for precise control of the water flow and pre-infusion time

Control panels:



Keyboard 5 selections standard



Keyboard 7 selections optional



MULTIFUNCTION TOUCH DISPLAY

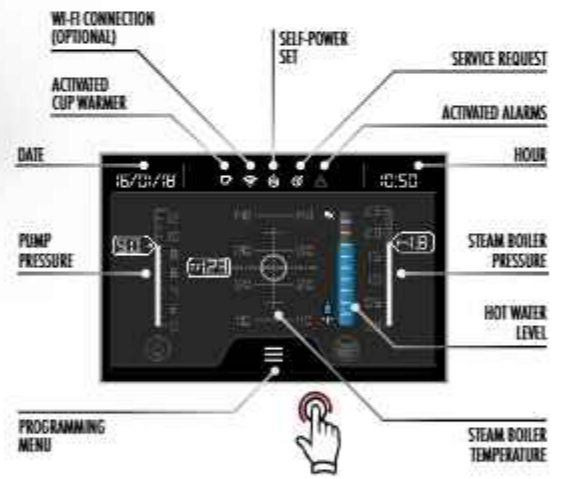

Characteristics

- INDEPENDENT REGULATION TEMPERATURE WATER COFFEE**
Maximum temperature precision and constancy of distribution.
- LED LIGHTING OF THE WORK AREA**
Allows efficient working in any condition of environmental lighting.
- EASY SERVICE**
Fast access to the internal parts for quick and easy technical service.
- TEMPCONTROL**
For a very-high thermal stability ($\pm 0.2^\circ\text{C}$).
- EXTERNAL VOLUMETRIC PUMP**
- MIXED INFUSION HOT WATER FOR TEA AND HERBAL TEAS**
Immediate mixing of cold / hot water for a better chemical and organoleptic quality.
- PROGRAMMABLE ELECTRONIC PRE-INFUSION**
Allows control with 0.1 second tolerance of the flow of water that wets the coffee bed, with programming of 4 different profiles for each group.
- AUTO-ON, AUTO-OFF AND DAY-OFF FUNCTION**
Programmable on-off timer for each day and/or daily timetables.
- GROUP FLUSHING**
With a simple pressure of the button a small quantity of water is dispensed to allow the group to be always clean.
- HIGH POWER STEAMER TERMINAL (bigger holes diameter)**
- STATIC RELAY BOILER TEMPERATURE**
Allows to regulate the temperature as accurately as possible.
- ENERGY SAVING SYSTEM**
Component insulation and smart electronics for maximum energy efficiency.
- OTHER**
- STAINLESS STEEL COFFEE BOILER**
Guarantees excellent stability and thermal precision, associated with resistance to oxidation and limestone.
- REALTIME STABILITY GROUP**
Exclusive Sanremo design that allows a precise maintenance of the set temperature.
- AUTOSTEAMER**
Steam wand characterized by an electronic system that allows to mount and/or heat milk at the set temperature.
- PROGRAMMABLE CUP WARMER TEMPERATURE**
Allows the cups to be kept at the optimum temperature in the most different climatic conditions.
- COMPETITION FILTERS**
Exclusive Sanremo design, with shape and volume designed to capture the best coffee aromas and fragrances.
- STEAM CONTROL ADJUSTABLE ELECTRONIC PRESSURE SWITCH**
Sensor with 0.02 bar precision that allows the chosen pressure and steam in the boiler to be kept constant in all conditions of use.

F18 SB



RoHS

Versions

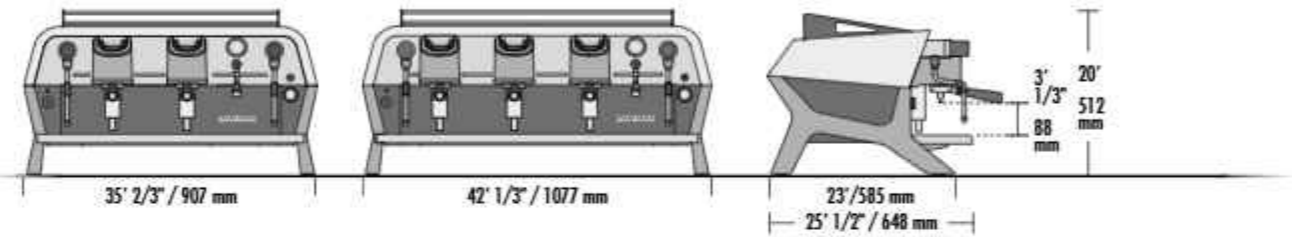

- 2 group**
- 2 steam taps
 - 1 water tap
 - 1 one-cup filter holder
 - 2 two-cup filter holders

- 3 group**
- 2 steam taps
 - 1 water tap
 - 1 one-cup filter holder
 - 3 two-cup filter holders

✓ "TALL" VERSION

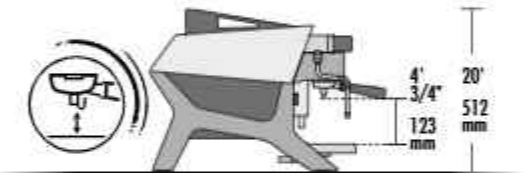

Colours

	Matte black/Matte black	RAL 9004
	Matte black/Matte white	RAL 9004/9003
	Matte black/Brown	RAL 9004/8019
	Matte black/Racing Red	RAL 9004/INVER 81784

CE

Technical data

		2 group	3 group
voltage	V	220-240 1N / 380-415 3N 50/60Hz	
max input boiler/steam boiler's resistor power	kW	3.2 / 2.7	5.65 / 5.1
		4.3 / 4.0	6.30 / 6.0
		5.0 / 4.5	
steam boiler capacity	lit	12	18
pump power	kW	0.15	0.15
cup-heater power	kW	0.20	0.25
net weight	lb / kg	172 / 78	211.5 / 96
gross weight (with shipping crate)	lb / kg	231.5 / 105	267 / 121

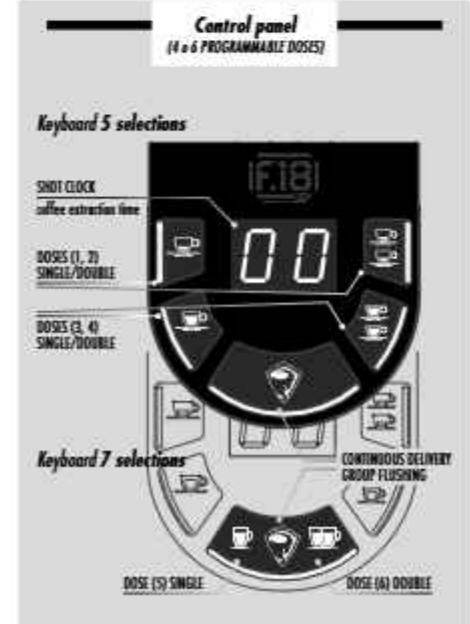



QUICK STEAM COUPLING

The completely new half-turn knob with INTEGRATED PURGE function, allows extreme precision limiting physical stress

GROUP SR 61
Chromed brass grouphead with thermosiphonic circulation system optimized to maintain the ideal coffee extraction temperature



ENERGY SAVING SYSTEM

Component insulation and smart electronics for maximum energy efficiency



DIE-CAST ALUMINIUM LEGS

Machine support made in die-cast aluminium



F18 SB
Link to the website

AUTOSTEAMER



FOAMING



STEAMING



AUTOMATIC CLEANING



HOT WATER



Autosteamer Version

MULTIFUNCTION DISPLAY

ECO MODE



IDLE MODE - TEMPERATURE



STEAM BOILER TEMPERATURE

FUNCTIONS



ACTIVATED CUP WARMER

DETECTED ALARM

ACTIVATED ECO MODE

STEAM BOILER PRESSURE

STEAM BOILER WATER LEVEL

REQUIRED SERVICE

ACTIVATED AUTOMATIC ON/OFF

CLOCK

Characteristics

- DIE-CAST ALUMINIUM LEGS**
- PRESSURE GAUGE**
Allows to monitor the inlet and pump pressure during extraction.
- ELECTRONIC AUTO-LEVEL**
Through an electronic level probe the boiler is automatically filled and maintained to the right filling level.
- STATIC RELAY BOILER TEMPERATURE**
Allows to regulate the temperature as accurately as possible thanks to the PID algorithm.
- GROUP FLUSHING**
With a simple pressure of the button a small quantity of water is dispensed to allow the group to be always clean.
- GROUP SR 61**
Chromed brass grouphead with thermosiphonic circulation system optimized to maintain the ideal coffee extraction temperature.
- CUP WARMER**
Dedicated resistor to keep all the cups at the optimal temperature. Power level programmable by user.
- AUTOMATIC CLEANING CYCLE**
Process for coffee groups cleaning. Cleaning cycles number programmable.
- MULTIFUNCTION DISPLAY**
Allows to monitor the right functioning of the machine and to program the main functions.
- PROGRAMMABLE ELECTRONIC PRE-INFUSION**
Allows control with 0.1 second tolerance of the flow of water that wets the coffee bed, with programming of 4 different profiles for each group.
- HIGH PERFORMANCE VOLUMETRIC PUMP**
Pressure stability also with prolonged and contemporary use of more than one group.

- ENERGY SAVING SYSTEM**
Component insulation and smart electronics for maximum energy efficiency.
- MIXED INFUSION HOT WATER FOR TEA AND HERBAL TEAS**
Immediate mixing of cold / hot water for a better chemical and organoleptic quality.
- AUTO-ON, AUTO-OFF AND DAY-OFF FUNCTION**
Programmable ON-OFF/ON-ECO timer for each day and/or daily timetables.
- EASY SERVICE**
Fast access to the internal parts for quick and easy technical service.
- AUTOSTEAMER**
Steam wand characterized by an electronic system which allows to froth milk and heat up beverages at a programmable temperature, different for every single function. Automatic cleaning cycle is included.
- EXTERNAL VOLUMETRIC PUMP**
- COMPETITION FILTERS**
Exclusive Sanremo design, with shape and volume designed to capture the best coffee aromas and fragrances.
- AISI 316L STAINLESS STEEL STEAM WAND "COLD TOUCH"**
Anti-burning feature even in conditions of prolonged use, fitted with "Latte Art" high-performance steam terminals.
- NAKED FILTER HOLDERS**
- PAYMENT SYSTEM**
RS-232 communication protocol to manage cash register systems.
- LED LIGHTING OF THE WORK AREA**
Allows efficient working in any condition of environmental lighting.
- ENHANCED RESISTANCE**

Verona RS



Versions

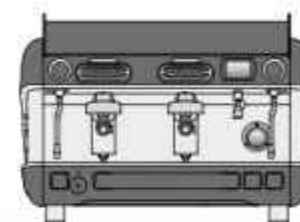

32' 1/4" / 818 mm

- 2 group RS**
 2 steam taps
 1 water tap
 1 one-cup filter holder
 2 two-cup filter holders

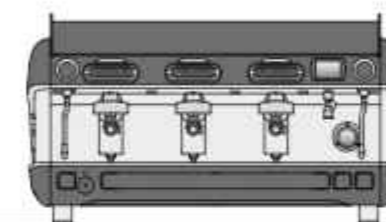

41' 1/4" / 1048 mm

- 3 group RS**
 2 steam taps
 1 water tap
 1 one-cup filter holder
 3 two-cup filter holders

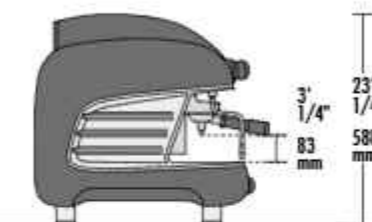

18" / 459 mm
 23' 1/2" / 599 mm

23' 1/4"
 588 mm

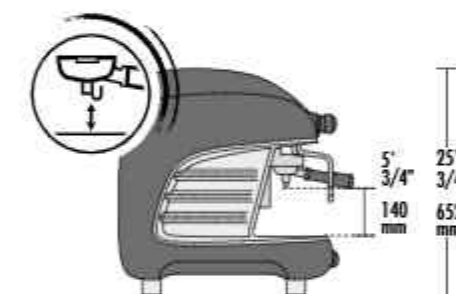

TALL VERSION

25' 3/4"
 652 mm

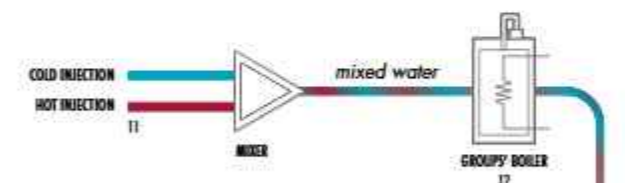

MULTIBOILER SYSTEM

Each group has a dedicated boiler powered by preheated water thanks to the mixing of cold and hot water coming from the heat exchangers; the group is kept at the ideal temperature by a specific resistor, which ensure a perfect thermal regulation.



Technical data

		2 group	3 group
voltage	V	220-240 1N / 380-415 3N	
max input boiler/steam boiler's resistor power	kW	5.3 / 3.5	6.0 / 3.5
steam boiler capacity	lt	8.6	10
pump power	kW	0.2	0.2
RS boiler capacity	lt	1	1.5
RS boiler element power	kW	1	1.5
cup-heater power	kW	0.20	0.25
net weight	lb / kg	150 / 68	187 / 85
gross weight (with shipping crate)	lb / kg	163 / 74	200 / 91

Colours

	Black	RAL 9005
	White	RAL 1013
	Red	RAL 3011



RS GROUP
Exclusive Sanremo design that allows an accurate maintenance of the set temperature



Realtime Stability

A sprint of technology

Single group display:



MULTIFUNCTIONAL DISPLAY

Touch display:

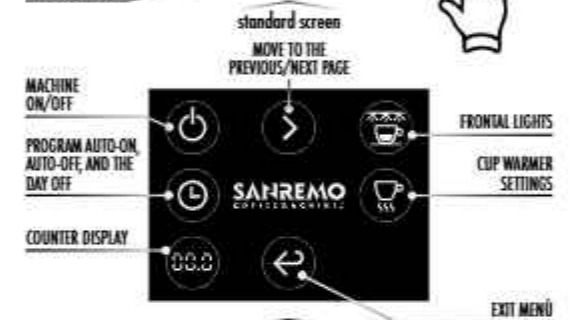

REALTIME STABILITY

Constancy in the electronic controlled temperature ($\pm 0.2^\circ\text{C}$)



PRE-INFUSION SYSTEM

Enabled pre-infusion start&stop for each group



STAINLESS STEEL "COLD TOUCH"

Anti-burning feature fitted with "Latte Art" high-performance steam terminals



Verona RS
Link to the website



ENERGY SAVING SYSTEM

Component insulation and smart electronics for maximum energy efficiency

Characteristics

- MIXED INFUSION HOT WATER FOR TEA AND HERBAL TEAS**
Immediate mixing of cold / hot water for a better chemical and organoleptic quality.
- ELECTRONIC AUTO-LEVEL**
Through an electronic level probe the boiler is automatically filled and maintained to the right filling level.
- STATIC RELAY BOILER TEMPERATURE**
Allows to regulate the temperature as accurately as possible.
- STAINLESS STEEL COFFEE BOILER**
Guarantees excellent stability and thermal precision, associated with resistance to oxidation and limestone.
- INDEPENDENT REGULATION TEMPERATURE WATER COFFEE**
Maximum temperature precision and constancy of distribution.
- PRE-INFUSION SYSTEM**
Enabled pre-infusion start&stop for each group.
- AISI 316L STAINLESS STEEL STEAM WAND "COOL TOUCH"**
Anti-burning feature even in conditions of prolonged use, fitted with "Latte Art" high-performance steam terminals.
- PROGRAMMABLE CUP WARMER POWER**
Electronic programmable cup warmer to keep cups warmed at the right temperature.
- LED LIGHTING OF THE WORK AREA**
Allows efficient working in any condition of environmental lighting.
- AUTO-ON, AUTO-OFF AND DAY-OFF FUNCTION**
Programmable on-off timer for each day and/or daily timetables.
- DOUBLE READING GAUGE**
Allows to control at the same time the boiler pressure and the distribution pressure.

- ENERGY SAVING SYSTEM**
Component insulation and smart electronics for maximum energy efficiency.
- RS GROUP**
Exclusive Sanremo design that allows a precise maintenance of the set temperature.
- EASY SERVICE**
Fast access to the internal parts for quick and easy technical service.
- CLEANING CYCLE**
Process for coffee groups cleaning.
- HIGH PERFORMANCE VOLUMETRIC PUMP**
Pressure stability also with prolonged and contemporary use of more than one group.
- COMPETITION FILTERS**
Exclusive Sanremo design, with shape and volume designed to capture the best coffee aromas and fragrances.
- TEMPCONTROL**
For a very-high thermal stability ($\pm 0.2^\circ\text{C}$).
- GROUP FLUSHING**
With a simple pressure of the button a small quantity of water is dispensed to allow the group to be always clean.

- Other**
- AUTOSTEAMER**
Steam wand characterized by an electronic system that allows to mount and/or heat milk at the set temperature.
 - EXTERNAL VOLUMETRIC PUMP**
 - HIGH POWER STEAMER TERMINAL (bigger holes diameter)**
 - STAINLESS FILTER HOLDERS**
 - ENHANCED RESISTANCE**

Verona



SED TECHNOLOGY
SED VERSION
Guarantees an electronic dosing system through the button panel

SAP TECHNOLOGY
SAP VERSION
Allows the semi-automatic programming of doses

124 °C 18:08
SANREMO

TIME AND TEMPERATURE DISPLAY

only mod. SED

GROUP SR 61
Optimized to maintain the ideal coffee extraction temperature



Verona
Link to the website

Characteristics



ELECTRONIC AUTO-LEVEL
Through an electronic level probe the boiler is automatically filled and maintained to the right filling level.



ACTIVATED ELECTRONIC PRE-INFUSION
Management of the delayed activation of water solenoid in the first phase of brewing.



EASY SERVICE
Fast access to the internal parts for quick and easy technical service.



STATIC RELAY BOILER TEMPERATURE
Allows to regulate the temperature as accurately as possible.



MULTIFUNCTION DISPLAY
Allows to monitor the right functioning of the machine and to program the main functions.



AUTOMATIC CLEANING CYCLE
Process for coffee groups cleaning.



DOUBLE READING GAUGE
Allows to control at the same time the boiler pressure and the distribution pressure.



GROUP SR 61
Chromed brass grouphead with thermosiphonic circulation system optimized to maintain the ideal coffee extraction temperature.

Colours

	Red	RAL 3002
	Matte black	RAL 9005
	Black	RAL 9005
	Silver	RAL 9006
	Pearl white	RAL 1013
	White	RAL 9003



Versions

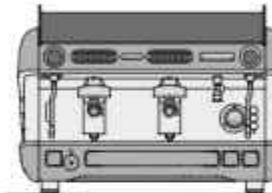

32' 2/4" / 820 mm

2 group SED/SAP
2 steam taps
1 water tap
1 one-cup filter holder
2 two-cup filter holders

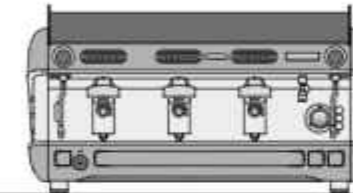

41' 2/4" / 1050 mm

3 group SED/SAP
2 steam taps
1 water tap
1 one-cup filter holder
3 two-cup filter holders

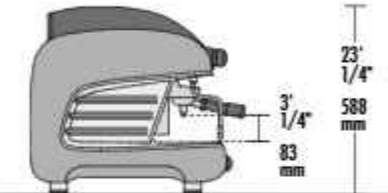

18' / 459 mm
23' 1/2" / 599 mm

23' 1/4" / 588 mm

3' 1/4" / 83 mm

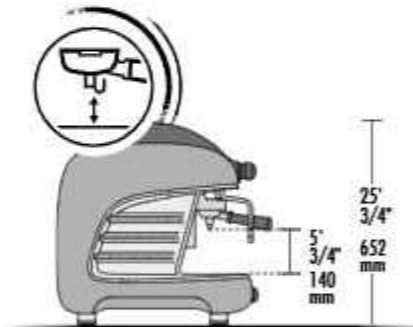

25' 3/4" / 652 mm

5' 3/4" / 140 mm

TALL VERSION

Other



AUTOSTEAMER
Steam wand characterized by an electronic system that allows to mount and/or heat milk at the set temperature.



COMPETITION FILTERS
Exclusive Sanremo design, with shape and volume designed to capture the best coffee aromas and fragrances.



EXTERNAL VOLUMETRIC PUMP



MIXED INFUSION HOT WATER FOR TEA AND HERBAL TEAS
Immediate mixing of cold / hot water for a better chemical and organoleptic quality.

Technical data

		2 group	3 group
voltage	V	220-240 1N / 380-415 3N	
max input boiler/steam boiler's resistor power	kW	3.3 / 2.7	5.35 / 5.1
		5.1 / 4.5	
steam boiler capacity	l	12.7	19
pump power	kW	0.15	0.15
net weight	lb / kg	150 / 68	187 / 85
gross weight (with shipping crate)	lb / kg	161 / 73	201 / 91

*4 group machine available upon request



CUP WARMER
Dedicated resistor to keep all the cups at the optimal temperature.



NAKED FILTER HOLDERS



ENHANCED RESISTANCE

Napoli



LEVER GROUP

High-performance lever group with Sanremo technology

TEMPERATURE SETTING DISPLAY

Allows the regulation of the water temperature



Characteristics



MANUAL BOILER LOAD
Allows to bypass the electronic-level control.



ELECTRONIC AUTO-LEVEL
Through an electronic level probe the boiler is automatically filled and maintained to the right filling level.



STATIC RELAY BOILER TEMPERATURE
Allows to regulate the temperature as accurately as possible.



GLASS LEVEL
Allows to monitor the water level in the boiler.



BOILER PRESSURE GAUGE
Allows to control the boiler pressure.



PUMP PRESSURE GAUGE
Allows to control the distribution pressure.



EASY SERVICE
Fast access to the internal parts for quick and easy technical service.



TEMPERATURE SETTING DISPLAY
Allows to regulate with precision the water temperature in the boiler for the production of coffee.

Other



EXTERNAL VOLUMETRIC PUMP



ENHANCED RESISTANCE



CUP WARMER
Dedicated resistor to keep all the cups at the optimal temperature.

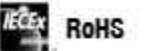

Versions

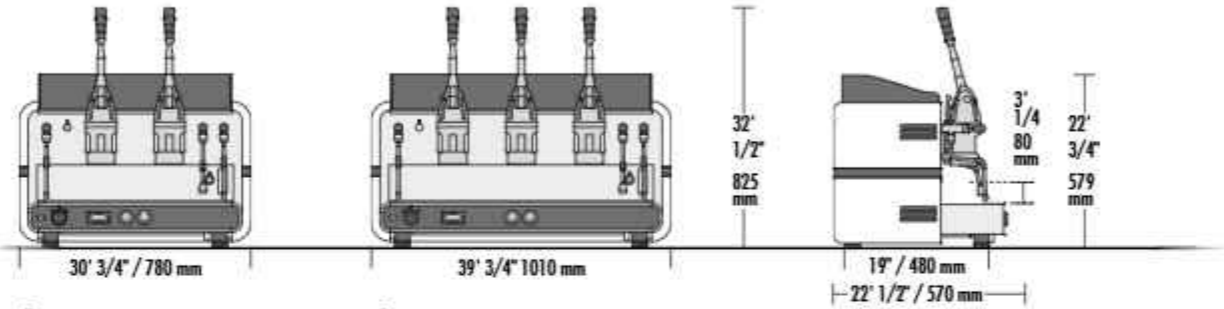

2 group
2 steam taps
1 water tap
1 one-cup filter holder
2 two-cup filter holders

3 group
2 steam taps
1 water tap
1 one-cup filter holder
3 two-cup filter holders

Colours

	Black	RAL 9005
	White	RAL 9003
	White/Matte black	RAL 9003/9005
	White/Red	RAL 9003/3002



Technical data

		2 group	3 group
voltage	V	220-240 1N / 380-415 3N	
max input boiler/steam boiler's resistor power	kW	3.85 / 3.5	5.80 / 5.5
		4.85 / 4.5	7.40 / 7.0
steam boiler capacity	l	12	19
pump power	kW	0.13	0.13
net weight	lb / kg	172 / 78	240 / 109
gross weight (with shipping crate)	lb / kg	194 / 88	254 / 115

*4 group machine available upon request



Napoli
Link to the website



Torino



RoHS

LED LIGHTING OF THE WORKING AREA

Allows to effectively work in any light condition (optional)



SED TECHNOLOGY

SED VERSION

Guarantees an electronic dosing system through the button panel

SAP TECHNOLOGY

SAP VERSION

Allows the semi-automatic programming of doses



GROUP SR 61

Optimized to maintain the ideal coffee extraction temperature



Versions

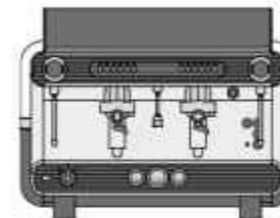

31" / 780 mm

2 group SED/SAP
2 steam taps
1 water tap
1 one-cup filter holder
2 two-cup filter holders

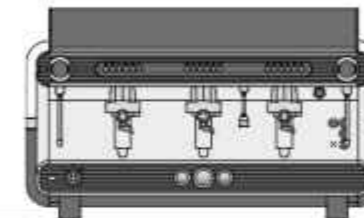

40" / 1010 mm

3 group SED/SAP
2 steam taps
1 water tap
1 one-cup filter holder
3 two-cup filter holders

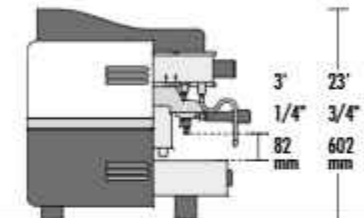

17" 1/3" / 440 mm
22" 1/2" / 570 mm

Colours

	Black	RAL 9005
	White	RAL 9003
	White/Matte black	RAL 9003/9005
	White/Red	RAL 9003/3002



Characteristics



Torino
Link to the website



ELECTRONIC AUTO-LEVEL
Through an electronic level probe the boiler is automatically filled and maintained to the right filling level.



PUMP PRESSURE GAUGE
Allows to control the distribution pressure.



EASY SERVICE
Fast access to the internal parts for quick and easy technical service.



ACTIVATED ELECTRONIC PRE-INFUSION
Management of the delayed activation of water solenoid in the first phase of brewing.



GROUP SR 61
Chromed brass grouphead with thermosiphonic circulation system optimized to maintain the ideal coffee extraction temperature.



AUTOMATIC CLEANING CYCLE
Process to clean the coffee groups.



BOILER PRESSURE GAUGE
Allows to control the boiler pressure.

Other



LED LIGHTING OF THE WORK AREA
Allows efficient working in any condition of environmental lighting.



EXTERNAL VOLUMETRIC PUMP



CUP WARMER
Dedicated resistor to keep all the cups at the optimal temperature.



NAKED FILTER HOLDERS



COMPETITION FILTERS
Exclusive Sanremo design, with shape and volume designed to capture the best coffee aromas and fragrances.



ENHANCED RESISTANCE



Technical data

		2 group	3 group
voltage	V	220-240 1N	380-415 3N
max input boiler/steam boiler's resistor power	kW	3.35 / 2.7	5.35 / 5.1
		5.1 / 4.5	
steam boiler capacity	lt	12	19
pump power	kW	0.15	0.15
net weight	lb / kg	139 / 63	196 / 89
gross weight (with shipping crate)	lb / kg	154 / 70	207 / 94

Zoe Competition



COLORED AND VERSATILE
Totally matching every type of decorative solution thanks to the possible customizations



SHOT TIMER
To accurately and reliably time coffee extraction



LED LIGHTING OF THE WORKING AREA
Allows to effectively work in any light condition



EASY SERVICE
Fast access to the internal parts for quick and easy technical service



LOW SERVICE COST
Designed to decrease the maintenance and inspection costs



Characteristics

ELECTRONIC AUTO-LEVEL
Through an electronic level probe the boiler is automatically filled and maintained to the right filling level.

ACTIVATED ELECTRONIC PRE-INFUSION
Management of the delayed activation of water solenoid in the first phase of brewing.

DOUBLE READING GAUGE
Allows to control at the same time the boiler pressure and the distribution pressure.

EASY SERVICE
Fast access to the internal parts for quick and easy technical service.

AUTOMATIC CLEANING CYCLE
Process for coffee groups cleaning.

LED LIGHTING OF THE WORK AREA
Allows efficient working in any condition of environmental lighting.

SHOT TIMER
To accurately and reliably time coffee extraction.

Other

AUTOSTEAMER
Steam wand characterized by an electronic system that allows to mount and/or heat milk at the set temperature.

CUP WARMER
Dedicated resistor to keep all the cups at the optimal temperature.

- EXTERNAL VOLUMETRIC PUMP**
- NAKED FILTER HODERS**
- ENHANCED RESISTANCE**

Versions

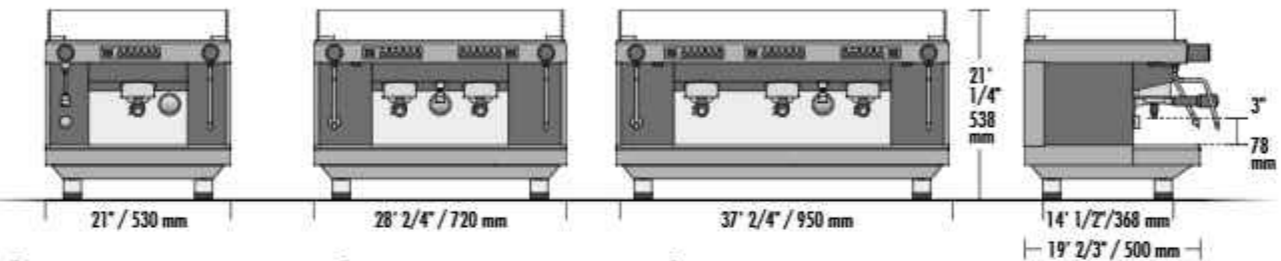

1 group
1 steam tap
1 water tap
1 one-cup filter holder
1 two-cup filter holder

2 group
2 steam taps
1 water tap
1 one-cup filter holder
2 two-cup filter holders

3 group
2 steam taps
1 water tap
1 one-cup filter holder
3 two-cup filter holders

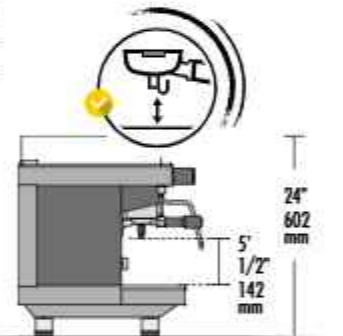

TALL VERSION
2-3 group

Technical data

		1 group	2 group	3 group
voltage	V	220-240 1N / 380-415 3N		
max input boiler/steam boiler's resistor power	kW	2.35 / 1.95	3.35 / 2.7	5.8 / 5.1
			4.3 / 4.0	
			4.8 / 4.5	
steam boiler capacity	lt	5	9	12.5
pump power	kW	0.15	0.15	0.15
net weight	lb / kg	93 / 42	121 / 55	152 / 69
gross weight (with shipping crate)	lb / kg	104 / 47	130 / 59	161 / 73



Colours

	Black	RAL 9005
	White/Black	RAL 9003/9005
	White/Matte black	RAL 9003/9005
	White/Red	RAL 9003/3002

PERSONALISED GRAPHICS

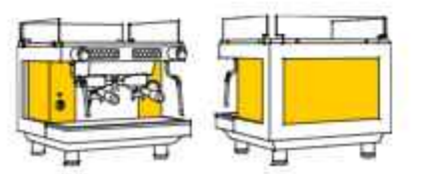

Zoe Competition
Link to the website

Customization of internal panels with graphics and colors (on request).

Zoe

46

COLORED AND VERSATILE

Totally matching every type of decorative solution thanks to the possible customizations



SED VERSION

Guarantees an electronic dosing system through the button panel



SAP VERSION

Allows the semi-automatic programming of doses



COMPLETE RANGE

Available versions: SED and SAP, 1-2-3 group, Tall and Compact



EASY SERVICE

Fast access to the internal parts for quick and easy technical service

LOW SERVICE COST

Designed to decrease the maintenance and inspection costs



Characteristics



ELECTRONIC AUTO-LEVEL

Through an electronic level probe the boiler is automatically filled and maintained to the right filling level.



ACTIVATED ELECTRONIC PRE-INFUSION

Management of the delayed activation of water solenoid in the first phase of brewing.



DOUBLE READING GAUGE

Allows to control at the same time the boiler pressure and the distribution pressure.



EASY SERVICE

Fast access to the internal parts for quick and easy technical service.



AUTOMATIC CLEANING CYCLE

Process for coffee groups cleaning.

Other



AUTOSTEAMER

Steam wand characterized by an electronic system that allows to mount and/or heat milk at the set temperature.



CUP WARMER

Dedicated resistor to keep all the cups at the optimal temperature.



EXTERNAL VOLUMETRIC PUMP



NAKED FILTER HOLDERS



ENHANCED RESISTANCE

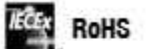

47

Versions

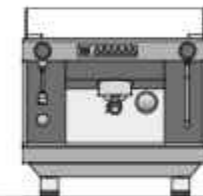

21" / 530 mm

1 group SED/SAP
1 steam tap
1 water tap
1 one-cup filter holder
1 two-cup filter holder

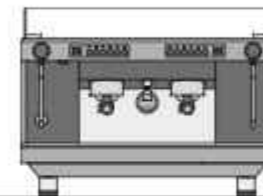

28" 2/4" / 720 mm

2 group SED/SAP
2 steam taps
1 water tap
1 one-cup filter holder
2 two-cup filter holders

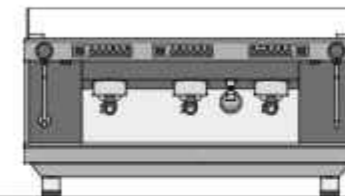

37" 2/4" / 950 mm

3 group SED/SAP
2 steam taps
1 water tap
1 one-cup filter holder
3 two-cup filter holders

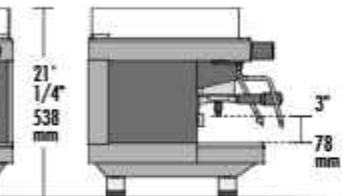

21" 1/4" / 538 mm

14" 1/2" / 368 mm

19" 2/3" / 500 mm

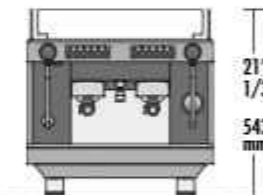

21" 1/3" / 543 mm

20" 3/4" / 530 mm

COMPACT VERSION

2 group
2 steam taps
1 water tap
1 one-cup filter holder
2 two-cup filter holders



TALL VERSION

2-3 group
SED
SAP

Technical data

		1 group	2 group	3 group	Kompact
voltage	V	220-240 1N / 380-415 3N			220-240 1N
max input boiler/steam boiler's resistor power	kW	2.35 / 1.95	3.35 / 2.7	5.8 / 5.1	2.7 / 2.5
			4.3 / 4.0		
			4.8 / 4.5		
steam boiler capacity	lit	5	9	12.5	7
pump power	kW	0.15	0.15	0.15	0.15
net weight	lb / kg	93 / 42	121 / 55	152 / 69	99 / 45
gross weight (with shipping crate)	lb / kg	104 / 47	130 / 59	161 / 73	113 / 51

Colours

	Black	RAL 9005
	White/Black	RAL 9003/9005
	White/Matte black	RAL 9003/9005
	White/Red	RAL 9003/3002

PERSONALISED GRAPHICS

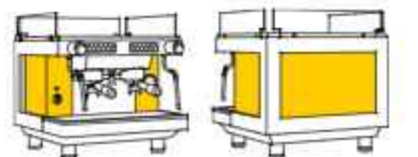

Zoe
Link to the website

Customization of internal panels with graphics and colors (on request).

Cube



STAINLESS STEEL "COLD TOUCH"

Anti-burning feature fitted with "Latte Art" high-performance steam terminals

STEAMBOOSTER

Increase the power of the steam wand, improving performance



MAIN DISPLAY USER

Views:
-Boiler temperature (range 239/ 258,8°F)
-Extraction time
-Water level
-Malfunction

Settings:
Water filter expiration date (1-12 mths)

APP CONNECTION



LED INDICATORS

- On/Off
- At temperature
- Water level alarm

ENERGY SAVING SYSTEM

Component insulation and smart electronics for maximum energy efficiency



PRESSURE GAUGE BOILER PRESSURE

Range 0-36 psi



PRESSURE GAUGE PUMP PRESSURE

Range 0-232 psi

Characteristics

- + 1.9L boiler in AISI 316 stainless steel
- + 1.8L internal water tank
- + Thermosyphon unit with mechanical pre-infusion
- + Boiler power 1500W/230Vac - 1300W/120Vac
- + 54 L/h high performance volumetric pump
- + Energy Saving System
- + WiFi connection with Web App
- + Water supply that can be selected from internal tank or mains
- + Digital display
- + Complete kit of useful accessories

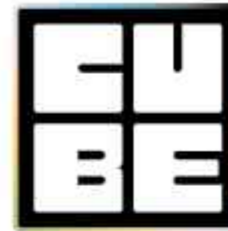

RoHS

Versions

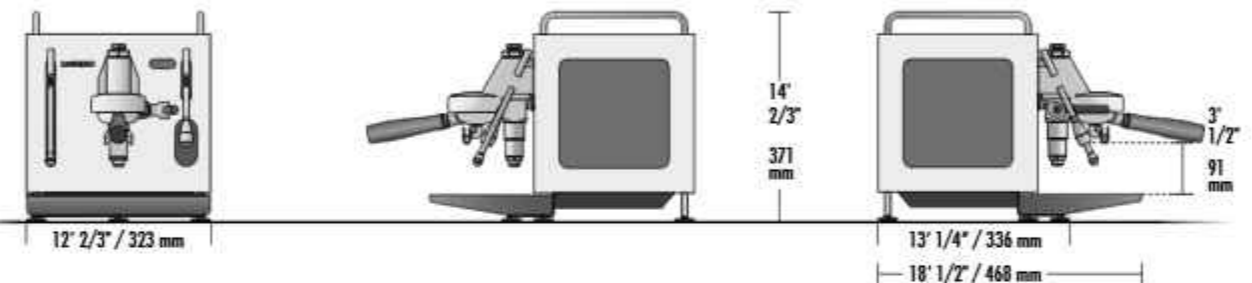

WeightKg 27,7 | 61 lbs



WiFi connection with Web App



It is possible to manage multiple machines - located in different places - using the same App.

- + Remote machine on/off
- + Set-up boiler temperature
- + Manage water tank level
- + Enable and manage water filter signaling
- + Show shot time in real time
- + Statistics: daily, weekly and monthly counters for coffee and water consumption
- + Weekly scheduler to program up to three different "time slot" per day

APP & WIFI TECHNOLOGY



CUBE



-  Snow White
-  Onyx Black
-  Stainless Steel
-  Azure Lake
-  Candy Pink
-  Matcha Green
-  Yolk Yellow
-  Racing Red



2 different body styles: A and B.

Cube A

In style A, the machine coating panels come in single colour.



Standard colours



Special colours



Cube B

In style B, the side panels feature two parts characterised by a two-colour finish.



Available finishes of the body



Available finishes for the central box





CUSTOMIZABLE PRESETS

USER-FRIENDLY

Intuitive touch screen display



FRONT LEVER (PADDLE)

Electronically managed to create and modify profiles

ENERGY SAVING SYSTEM

Component insulation and smart electronics for maximum energy efficiency

MULTI-BOILER

The boilers for both the coffee and the auxiliary services are made from AISI 316 stainless steel, and are fully insulated

FULL CONFIGURATION

Equipped with tank (2,5l) and water mains connection

CONNECTIVITY

USB and Wifi

VOLUMETRIC PUMP

*24V High performance
Excellent stability
during profiling*

(*) WiFi module during the year 2023

Characteristics



MIXED INFUSION HOT WATER FOR TEA AND HERBAL TEAS
Immediate mixing of cold / hot water for a better chemical and organoleptic quality.



AUTO-ON, AUTO-OFF AND DAY-OFF FUNCTION
Programmable ON-OFF/ON-ECO timer for each day and/or daily timetables.



TEMPCONTROL
For a very-high thermal stability (± 0.2 °C).



STATIC RELAY BOILER TEMPERATURE
Allows to regulate the temperature as accurately as possible.



EASY SERVICE
Fast access to the internal parts for quick and easy technical service.



GROUP FLUSHING
With a simple pressure of the button a small quantity of water is dispensed to allow the group to be always clean.



STAINLESS STEEL COFFEE BOILER
Guarantees excellent stability and thermal precision, associated with resistance to oxidation and limestone.



AUTOMATIC CLEANING CYCLE
Process for coffee group cleaning.



VOLUMETRIC PUMP
A new generation of pump to amplifying your experience

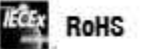

Versions

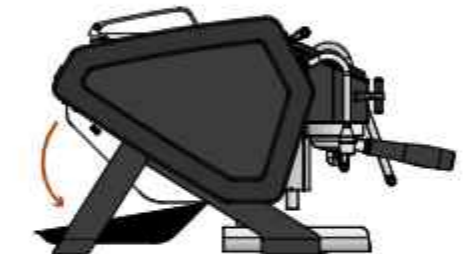
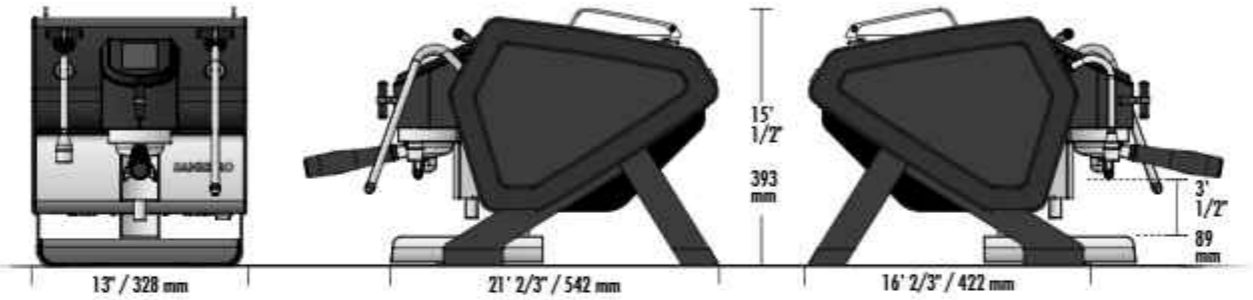

Technical data

voltage/max input boiler	V	220-240V / 50-60HZ / 2.20 kW
		110-120V / 50-60HZ / 1.65 kW
		100V / 50-60HZ / 1.45 kW
coffee boiler's resistor power	W	500
steam boiler capacity	lt	1
coffee boiler capacity	l	0.5
net weight	lb / kg	70.5 / 32
	lb / kg	79 / 36

Colors

	Black: matt/glossy (side frames)	RAL 9005
	White: matt/glossy legs and side	RAL 9003 RAL 9005
	White: matt/glossy (side frames)	RAL 9003

Customizations available, see YOU_KIT catalogue for more info.



You
Watch the video

Customizable Presets

Extraction profiles customizable and savable:

- 6 standard profiles with optimal parameters presets
- 12 completely customizable profiles in all 3 extraction phases, with a capacity to disable pre-infusion and post-infusion the Paddle
- Set your manual profiles from the Paddle



Electronic Paddle

Manually create your profiles:

Configure the Paddle (right/left) based on your gestures.



54

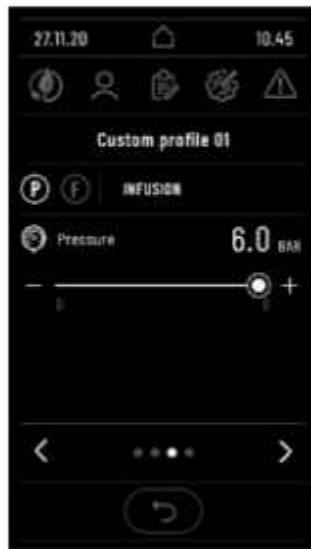

YOU
MADE FOR YOU BY SAHREMO



Extraction mode

Check your extraction in real time verifying pressure-flow rate

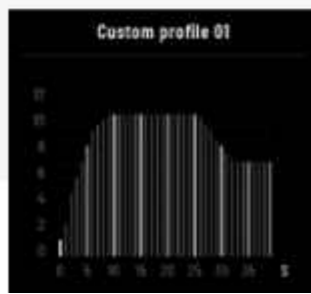
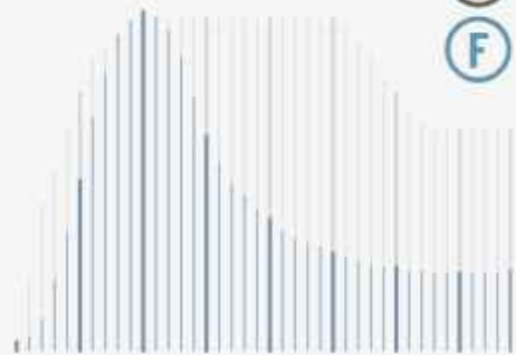

Energy efficiency



Setting:

- Automatic: allows the user to associate up to 6 daily time frames.
- Manual: allows the user to turn the machine or the individual boilers on and off manually.

Two programmable modes:

- Stand-by: low power consumption condition, compliant with the ErP Directive (2009/125/EC).
- Eco: keeps the machine on, but at a reduced temperature for quick start-up.

For both, the user can enable the Energy Saving function, which automatically turns the machine off after the set time.

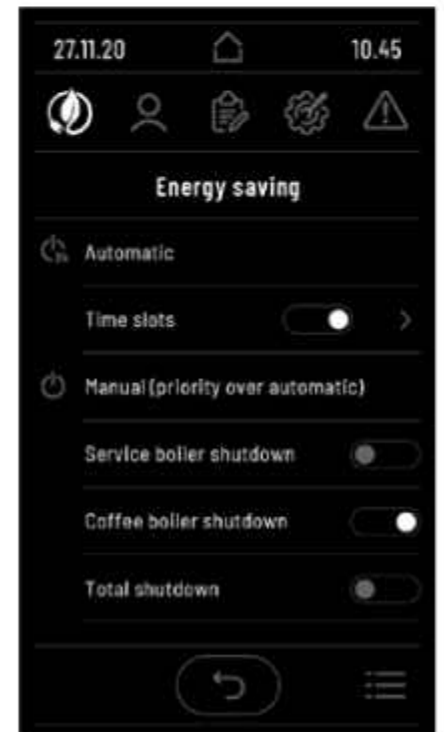

Grinders



GRINDERS
SAIREMO

X-ONE

58



HIGH PERFORMANCE

Vertical flat burrs (ø 98 mm)
Burrs with DLC coating

INTEGRATED INDUSTRIAL GRADE WEIGHING

Only the requested dose is grinded
Patented "WEIGHT BY BEANS" technology to weigh beans before grinding

EVERYTHING UNDER CONTROL

Display full touch screen



GRINDING SPEED

3 standard speeds: 1000 rpm
1200 rpm
1400 rpm

1 custom speed, range 800-1400rpm
Selectable by user on digital display

PRESET RECIPES

You can save up to 12 customized recipes - you can set weight, grinding speed and burrs distance. Save & upload on USB

GRINDING CHAMBER

Always empty.
No coffee is wasted

3 GRINDERS IN 1

BY-PASS

Can be used as single dose or up to 250 gr



GRINDING MOTOR

Managed by an inverter to control grinding speed



Characteristics



EMPTY CHAMBER

No more coffee is wasted and no more oxidation avoiding rancid flavours.

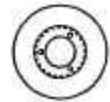

VERTICAL FLAT BURRS

98 mm vertical flat burrs with DLC coating to reduce friction of coffee and increase life span.



EASY SETTING

Electronic burrs' spacing adjustment.



INDUSTRIAL WEIGHING SYSTEM

Industrial weighing system, for 5 to 30 gr for each hopper.



PREDOSING FEATURE

Automatically refill your dose to improve the productivity.



HOPPERS

Two independent hoppers for different coffees and recipes.



BYPASS

Useful for single dose or up to 250 gr, independent with its own setting.



FLEXIBILITY

Manual dosing pushbutton for each hopper.



SPACE FOR COFFEE BAG

Easy removable portafilter holder.



HEALTH

Hoppers and bypass use material "PBA-Free".



COOLING SYSTEM

Temperature controlled cooling system.



RoHS

59

Benefits of single dose

Volatile compounds in roasted and ground coffee. Effect of time in coffee aroma intensity.

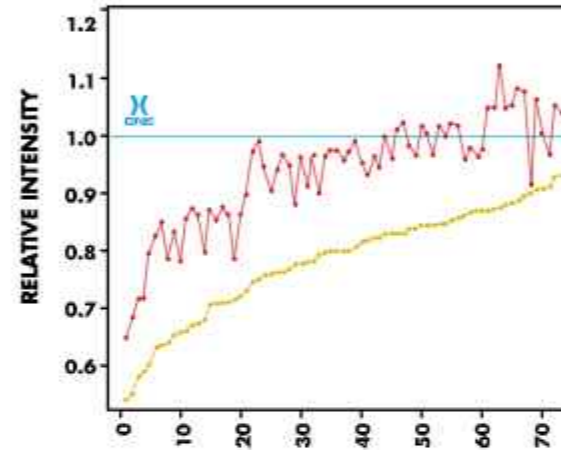

Molecular mass (m/z)
Each dot is a different chemical compound found inside coffee

AROMA INTENSITY CHART

- X-ONE Single dose grinding reference intensity line
- On-demand Coffee compound intensity 1min after grinding
- On-demand Coffee compound intensity 20min after grinding

RESULT

HIGHEST AROMA CONTENT IN SINGLE DOSING (X-ONE).

SIGNIFICANT DECREASE OF AROMA CONTENT WHEN COFFEE IS WAITING IN THE ON-DEMAND GRINDER FOR NEXT DOSE AS RETENTION BUILDS.

Technical data

		X-ONE
Version 1	W	100-127Vac / 50-60Hz / 1550W
Version 2	W	200-240Vac / 50-60Hz / 1650W
burrs' type	-	3.85"/98 mm vertical flat
motor speed	rpm	800-1400
coffee beans hopper capacity	lb / kg	2x2.6 / 2x1.2
by-pass capacity	lb / gr	0.55 / 250
net weight	lb / kg	79 / 36
width	inch / mm	9" / 230
height	inch / mm	23" / 580
dept	inch / mm	20" / 510

SPACE SAVING



Footprint impact of three standard grinders.



Colour

Black



To find out more about the Sanremo X-One

On demand / Grinder doser

SR 83 OD



HIGHT PERFORMANCE

Flat burrs (ø 83 mm)
"Red speed" burrs (optional)



PRECISE GRINDING ADJUSTMENT

Mechanical micrometric with ring nut

EVERYTHING UNDER CONTROL

Display full touch screen

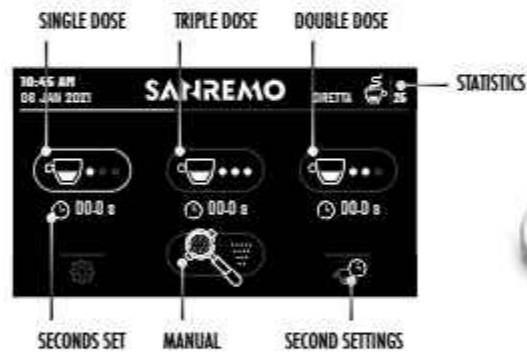

Optional



"RED SPEED" BURRS
Improves the quality of grinding and offers a much longer life span. (PVD-coated)



INVERTER TECHNOLOGY

The system ensures absolute precision and consistency for grinding, reducing motor consumption, operating noiselessly and showing exceptional reliability even during long time operations.

Technical data		SR 83 OD
power	W	650
burrs	-	flat
disks diameter	inch / mm	3' 1/4" / 83
motor speed 50 Hz	rpm	1350
motor speed 60 Hz	rpm	1550
coffee beans hopper capacity	lb / kg	3.3 / 1.5
net weight	lb / kg	33 / 15
width	inch / mm	9" / 230
height	inch / mm	26' 2/4" / 670
dept	inch / mm	10' 3/4" / 270

On demand / Conical grinder doser

SR 64 OD



HIGHT PERFORMANCE

Flat burrs (ø 83 mm)
"Red speed" burrs (optional)



PRECISE GRINDING ADJUSTMENT

Mechanical micrometric with ring nut

EVERYTHING UNDER CONTROL

Display full touch screen

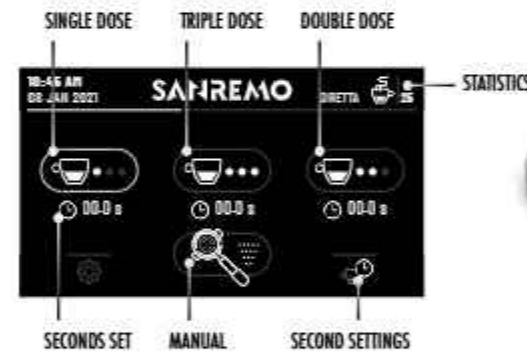

Grinders
Link to the website

Colours	
	Matt White
	Pearl White
	Gloss Red
	Silver
	Nardo Gray
	Matt Black
	Gloss Black

* Shiny aluminium version available on request, with a price increase

Technical data		SR 64 OD
power	W	350
burrs	-	flat
disks diameter	inch / mm	2' 2/4" / 64
motor speed 50 Hz	rpm	1350
motor speed 60 Hz	rpm	1550
coffee beans hopper capacity	lb / kg	3.3 / 1.5
net weight	lb / kg	28.6 / 13
width	inch / mm	9" / 230
height	inch / mm	24' 1/4" / 615
dept	inch / mm	10' 3/4" / 270

On demand / Grinder doser

ON DEMAND



SR 83 OD PRO

62



HIGHT PERFORMANCE

Flat burrs (ø 83 mm)
"Red speed" burrs (optional)

EVERYTHING UNDER CONTROL

Display full touch screen

PRECISE GRINDING ADJUSTMENT

Mechanical micrometric with ring nut

DETACHABLE GRINDING CHAMBER

Easy to release
Available for SR 83 OD PRO and SR 64 OD EVO PRO

Optional



"RED SPEED" BURRS
Improves the quality of grinding and offers a much longer life span. (PVD-coated)

Available for SR 83 OD, SR 64 OD EVO and SR 64 OD EVO PRO models.

Technical data

		SR 83 OD PRO
power	W	650
burrs	-	flat
disks diameter	inch / mm	3' 1/4" / 83
motor speed 50 Hz	rpm	1350
motor speed 60 Hz	rpm	1550
coffee beans hopper capacity	lb / kg	3.3 / 1.5
net weight	lb / kg	33 / 15
width	inch / mm	9" / 230
height	inch / mm	26' 2/4" / 670
dept	inch / mm	10' 3/4" / 270



On demand / Grinder doser

ON DEMAND



SR 64 OD EVO PRO

63



HIGHT PERFORMANCE

Flat burrs (ø 83 mm)
"Red speed" burrs (optional)

EVERYTHING UNDER CONTROL

Display full touch screen

PRECISE GRINDING ADJUSTMENT

Mechanical micrometric with ring nut

DETACHABLE GRINDING CHAMBER

Easy to release
Available for SR 83 OD PRO and SR 64 OD EVO PRO

Colours

	Matt White
	Pearl White
	Glass Red
	Silver
	Nardo Gray
	Matt Black
	Glass Black

* Shiny aluminium version available on request, with a price increase

Technical data

		SR 64 OD EVO PRO	SR 64 OD EVO
power	W	350	350
burrs	-	flat	flat
burrs diameter	inch / mm	2' 2/4" / 64	2' 2/4" / 64
motor speed 50 Hz	rpm	1350	1350
motor speed 60 Hz	rpm	1550	1550
coffee beans hopper capacity	lb / kg	3.3 / 1.5	3.3 / 1.5
net weight	lb / kg	28.6 / 13	28.6 / 13
width	inch / mm	9" / 230	9" / 230
height	inch / mm	24' 1/4" / 615	24' 1/4" / 615
dept	inch / mm	10' 3/4" / 270	10' 3/4" / 270



AllGround

CUBE



CUBE Grinders AllGround



Snow White



Onyx Black



Stainless Steel



Azure Lake



Candy Pink



Matcha Green



Yolk Yellow



Racing Red



Technical data

power	W	250
burrs	-	flat with titanium coating
burrs diameter	inch / mm	2' 2/4" / 64
motor speed 50 Hz	rpm	1400
motor speed 60 Hz	rpm	1600
coffee beans hopper capacity	lb / kg	0.55 / 0.25
net weight	lb / kg	19.8 / 9
width	inch / mm	6' 3/4" / 169
height	inch / mm	17' 1/4" / 440
dept	inch / mm	9' 2/4" / 240

CE

made for
each other



