











EXOPLISMOS  
online Εξοπλισμός Μαζικής Εστίασης  
[www.exoplismosonline.gr](http://www.exoplismosonline.gr)



# ΠΕΡΙΕΧΟΜΕΝΑ - INDEX

<b>ΣΕΛΙΔΑ</b> <i>PAGE</i>	<b>3</b>	<b>ΤΡΑΠΕΖΙΑ ΕΡΓΑΣΙΑΣ</b> <i>WORK TABLES</i>	
<b>ΣΕΛΙΔΑ</b> <i>PAGE</i>	<b>10</b>	<b>ΕΡΜΑΡΙΑ</b> <i>WORK CUPBOARDS</i>	
<b>ΣΕΛΙΔΑ</b> <i>PAGE</i>	<b>24</b>	<b>ΡΑΦΙΑ</b> <i>SHELVES</i>	
<b>ΣΕΛΙΔΑ</b> <i>PAGE</i>	<b>30</b>	<b>ΕΡΜΑΡΙΑ ΚΑΦΕ</b> <i>COFFEE STATION CUPBOARDS</i>	
<b>ΣΕΛΙΔΑ</b> <i>PAGE</i>	<b>38</b>	<b>ΜΟΝΑΔΕΣ ΜΠΑΡ</b> <i>BAR STATIONS</i>	
<b>ΣΕΛΙΔΑ</b> <i>PAGE</i>	<b>42</b>	<b>ΛΑΝΤΖΕΣ</b> <i>SINK UNITS</i>	
<b>ΣΕΛΙΔΑ</b> <i>PAGE</i>	<b>60</b>	<b>ΦΟΥΣΚΕΣ - ΑΠΟΡΡΟΦΗΤΗΡΕΣ</b> <i>RANGE HOOD</i>	
<b>ΣΕΛΙΔΑ</b> <i>PAGE</i>	<b>64</b>	<b>ΜΠΕΝ ΜΑΡΙ</b> <i>BAIN MARIE</i>	
<b>ΣΕΛΙΔΑ</b> <i>PAGE</i>	<b>66</b>	<b>ΘΕΡΜΑΙΝΟΜΕΝΕΣ ΒΙΤΡΙΝΕΣ</b> <i>HEATED DISPLAY CASES</i>	

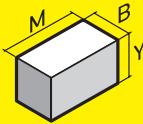
# ΠΕΡΙΕΧΟΜΕΝΑ - INDEX

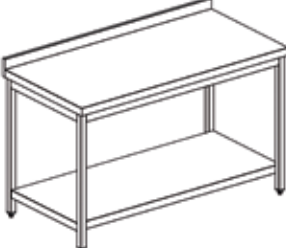
<b>ΣΕΛΙΔΑ</b> <i>PAGE</i>	<b>68</b>	<b>ΣΤΟΦΕΣ</b> <i>PROOFING CABINETS</i>	
<b>ΣΕΛΙΔΑ</b> <i>PAGE</i>	<b>70</b>	<b>ΠΟΤΗΡΙΕΡΕΣ</b> <i>WALL CUPBOARDS</i>	
<b>ΣΕΛΙΔΑ</b> <i>PAGE</i>	<b>72</b>	<b>ΝΤΟΥΛΑΠΕΣ</b> <i>HIGH CUPBOARDS</i>	
<b>ΣΕΛΙΔΑ</b> <i>PAGE</i>	<b>74</b>	<b>ΟΜΑΔΑ ΡΑΦΙΩΝ</b> <i>SHELVING UNITS</i>	
<b>ΣΕΛΙΔΑ</b> <i>PAGE</i>	<b>78</b>	<b>ΠΛΥΝΤΗΡΙΑ</b> <i>WASHING UNITS</i>	
<b>ΣΕΛΙΔΑ</b> <i>PAGE</i>	<b>82</b>	<b>ΚΑΡΟΤΣΙΑ ΤΡΟΧΗΛΑΤΑ</b> <i>TROLLEYS</i>	
<b>ΣΕΛΙΔΑ</b> <i>PAGE</i>	<b>84</b>	<b>ΜΟΝΑΔΕΣ ΑΠΟΘΗΚΕΥΣΗΣ</b> <i>STORAGE UNITS</i>	
<b>ΣΕΛΙΔΑ</b> <i>PAGE</i>	<b>85</b>	<b>ΖΑΧΑΡΟΠΛΑΣΤΕΙΟ</b> <i>PÂTISSERIE - BAKERY</i>	
<b>ΣΕΛΙΔΑ</b> <i>PAGE</i>	<b>86</b>	<b>ΕΞΑΡΤΗΜΑΤΑ</b> <i>ACCESSORIES</i>	

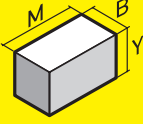

600		Διαστάσεις Dimensions (M x B x Y mm)	ΧΩΡΙΣ ΠΑΝΩΣΗΚΩΜΑ WITHOUT UPSTAND			ΜΕ ΠΑΝΩΣΗΚΩΜΑ WITH UPSTAND		
			Μοντέλο Model	Κωδικός Code	Τιμή € Price €	Μοντέλο Model	Κωδικός Code	Τιμή € Price €
Με ράφι With shelf		600 600 860	TRE 6-6	20106060		TREP 6-6	20206060	
		700 600 860	TRE 7-6	20107060		TREP 7-6	20207060	
		800 600 860	TRE 8-6	20108060		TREP 8-6	20208060	
		900 600 860	TRE 9-6	20109060		TREP 9-6	20209060	
		1000 600 860	TRE 10-6	20110060		TREP 10-6	20210060	
		1100 600 860	TRE 11-6	20111060		TREP 11-6	20211060	
		1200 600 860	TRE 12-6	20112060		TREP 12-6	20212060	
		1300 600 860	TRE 13-6	20113060		TREP 13-6	20213060	
		1400 600 860	TRE 14-6	20114060		TREP 14-6	20214060	
		1500 600 860	TRE 15-6	20115060		TREP 15-6	20215060	
		1600 600 860	TRE 16-6	20116060		TREP 16-6	20216060	
		1700 600 860	TRE 17-6	20117060		TREP 17-6	20217060	
		1800 600 860	TRE 18-6	20118060		TREP 18-6	20218060	
		1900 600 860	TRE 19-6	20119060		TREP 19-6	20219060	
* 6 πόδια - 6 legs		2000 600 860	TRE 20-6	20120060		TREP 20-6	20220060	
		2100 600 860	TRE 21-6	20121060		TREP 21-6	20221060	
		2200 600 860	TRE 22-6*	20122060		TREP 22-6*	20222060	
		2300 600 860	TRE 23-6*	20123060		TREP 23-6*	20223060	
		2400 600 860	TRE 24-6*	20124060		TREP 24-6*	20224060	
		2500 600 860	TRE 25-6*	20125060		TREP 25-6*	20225060	
		2600 600 860	TRE 26-6*	20126060		TREP 26-6*	20226060	

600		Διαστάσεις Dimensions (M x B x Y mm)	ΧΩΡΙΣ ΠΑΝΩΣΗΚΩΜΑ WITHOUT UPSTAND			ΜΕ ΠΑΝΩΣΗΚΩΜΑ WITH UPSTAND		
			Μοντέλο Model	Κωδικός Code	Τιμή € Price €	Μοντέλο Model	Κωδικός Code	Τιμή € Price €
Με δέσιμο 3 μεριές With 3 point frame		600 600 860	TRED 6-6	20306060		TREDP 6-6	20406060	
		700 600 860	TRED 7-6	20307060		TREDP 7-6	20407060	
		800 600 860	TRED 8-6	20308060		TREDP 8-6	20408060	
		900 600 860	TRED 9-6	20309060		TREDP 9-6	20409060	
		1000 600 860	TRED 10-6	20310060		TREDP 10-6	20410060	
		1100 600 860	TRED 11-6	20311060		TREDP 11-6	20411060	
		1200 600 860	TRED 12-6	20312060		TREDP 12-6	20412060	
		1300 600 860	TRED 13-6	20313060		TREDP 13-6	20413060	
		1400 600 860	TRED 14-6	20314060		TREDP 14-6	20414060	
		1500 600 860	TRED 15-6	20315060		TREDP 15-6	20415060	
		1600 600 860	TRED 16-6	20316060		TREDP 16-6	20416060	
		1700 600 860	TRED 17-6	20317060		TREDP 17-6	20417060	
		1800 600 860	TRED 18-6	20318060		TREDP 18-6	20418060	
		1900 600 860	TRED 19-6	20319060		TREDP 19-6	20419060	
* 6 πόδια - 6 legs		2000 600 860	TRED 20-6	20320060		TREDP 20-6	20420060	
		2100 600 860	TRED 21-6	20321060		TREDP 21-6	20421060	
		2200 600 860	TRED 22-6*	20322060		TREDP 22-6*	20422060	
		2300 600 860	TRED 23-6*	20323060		TREDP 23-6*	20423060	
		2400 600 860	TRED 24-6*	20324060		TREDP 24-6*	20424060	
		2500 600 860	TRED 25-6*	20325060		TREDP 25-6*	20425060	
		2600 600 860	TRED 26-6*	20326060		TREDP 26-6*	20426060	

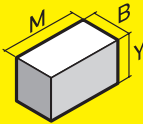
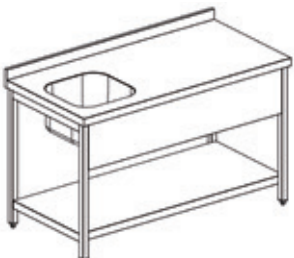
## ΤΡΑΠΕΖΙΑ ΕΡΓΑΣΙΑΣ ΜΕ ΓΟΥΡΝΑ WORK TABLES WITH SINK

600		Διαστάσεις Dimensions	Μοντέλο Model	Κωδικός Code	Τιμή € Price €
		(M x B x Y mm)			
<p>Γούρνα 400x400, με πανωσήκωμα &amp; κάτω ράφι Sink 400x400, with upstand &amp; bottom shelf</p> 		1000 600 860	TREPG 10-6	20510060	
		1100 600 860	TREPG 11-6	20511060	
		1200 600 860	TREPG 12-6	20512060	
		1300 600 860	TREPG 13-6	20513060	
		1400 600 860	TREPG 14-6	20514060	
		1500 600 860	TREPG 15-6	20515060	
		1600 600 860	TREPG 16-6	20516060	
		1700 600 860	TREPG 17-6	20517060	
		1800 600 860	TREPG 18-6	20518060	
		1900 600 860	TREPG 19-6	20519060	
		2000 600 860	TREPG 20-6	20520060	
		2100 600 860	TREPG 21-6	20521060	

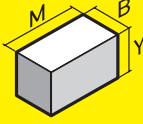
## ΚΑΤΩ ΚΑΙ ΜΕΣΑΙΑ ΡΑΦΙΑ BOTTOM AND MIDDLE SHELVES

600		Διαστάσεις Dimensions	Μοντέλο Model	Κωδικός Code	Τιμή € Price €
		(M x B x Y mm)			
<p>Ράφι μετά λείανσης Smooth shelf</p> 		600 600 45	RF 6-6	20606060	
		700 600 45	RF 7-6	20607060	
		800 600 45	RF 8-6	20608060	
		900 600 45	RF 9-6	20609060	
		1000 600 45	RF 10-6	20610060	
		1100 600 45	RF 11-6	20611060	
		1200 600 45	RF 12-6	20612060	
		1300 600 45	RF 13-6	20613060	
		1400 600 45	RF 14-6	20614060	
		1500 600 45	RF 15-6	20615060	
		1600 600 45	RF 16-6	20616060	
		1700 600 45	RF 17-6	20617060	
		1800 600 45	RF 18-6	20618060	
		1900 600 45	RF 19-6	20619060	
		2000 600 45	RF 20-6	20620060	
		2100 600 45	RF 21-6	20621060	
		2200 600 45	RF 22-6	20622060	
2300 600 45	RF 23-6	20623060			
2400 600 45	RF 24-6	20624060			
2500 600 45	RF 25-6	20625060			
2600 600 45	RF 26-6	20626060			

600		Διαστάσεις Dimensions (M x B x Y mm)	Μοντέλο Model	Κωδικός Code	Τιμή € Price €
-----	---	--	------------------	-----------------	-------------------

Συρτάρι (Y=150 mm)  
 Drawer (Y=150 mm)

450	600	150
550	600	150

ENS1 45-60  
 ENS1 55-60

23104560  
 23105560

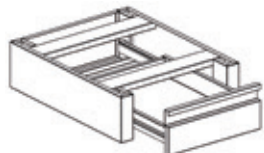

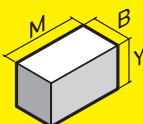
600		Διαστάσεις Dimensions (M x B x Y mm)	Μοντέλο Model	Κωδικός Code	Τιμή € Price €
-----	---	--	------------------	-----------------	-------------------

Συρταριέρα με 2 συρτάρι  
 2-Drawer unit

450	600	590
550	600	590

ENS2 45-60  
 ENS2 55-60

23204560  
 23205560

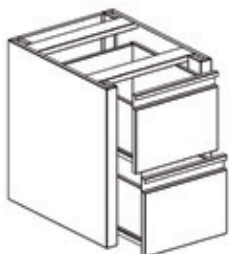

600		Διαστάσεις Dimensions (M x B x Y mm)	Μοντέλο Model	Κωδικός Code	Τιμή € Price €
-----	---	--	------------------	-----------------	-------------------

Συρταριέρα με 3 συρτάρι  
 3-Drawer unit

450	600	590
550	600	590

ENS3 45-60  
 ENS3 55-60

23304560  
 23305560

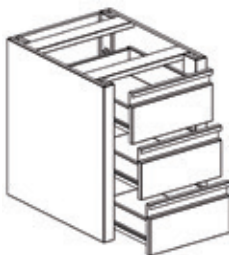

600		Διαστάσεις Dimensions (M x B x Y mm)	Μοντέλο Model	Κωδικός Code	Τιμή € Price €
-----	---	--	------------------	-----------------	-------------------

Συρταριέρα με 4 συρτάρι  
 4-Drawer unit

450	600	590
550	600	590

ENS4 45-60  
 ENS4 55-60

23404560  
 23405560

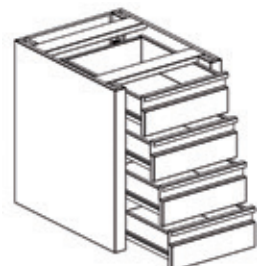

<b>600</b> 	<b>Διαστάσεις</b> <b>Dimensions</b> (M x B x Y mm)	<b>Μοντέλο</b> <b>Model</b>	<b>Κωδικός</b> <b>Code</b>	<b>Τιμή €</b> <b>Price €</b>
--	--	--------------------------------	-------------------------------	---------------------------------

Κλειδαριά  
 Lock

STE - LCK

80000000



<b>600</b> 	<b>Διαστάσεις</b> <b>Dimensions</b> (M x B x Y mm)	<b>Μοντέλο</b> <b>Model</b>	<b>Κωδικός</b> <b>Code</b>	<b>Τιμή €</b> <b>Price €</b>
--	--	--------------------------------	-------------------------------	---------------------------------

Αμπάρι  
 Hopper

450	<b>600</b>	590
550	<b>600</b>	590



ABE 4-6

23504560

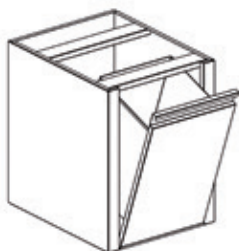

ABE 5-6

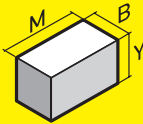
23505560

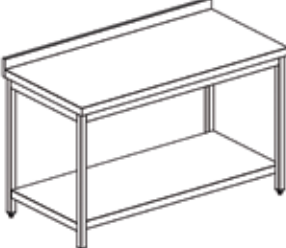

700		Διαστάσεις Dimensions (M x B x Y mm)	ΧΩΡΙΣ ΠΑΝΩΣΗΚΩΜΑ WITHOUT UPSTAND			ΜΕ ΠΑΝΩΣΗΚΩΜΑ WITH UPSTAND		
			Μοντέλο Model	Κωδικός Code	Τιμή € Price €	Μοντέλο Model	Κωδικός Code	Τιμή € Price €
Με ράφι With shelf	 	600 700 860	TRE 6-7	20106070		TREP 6-7	20206070	
		700 700 860	TRE 7-7	20107070		TREP 7-7	20207070	
		800 700 860	TRE 8-7	20108070		TREP 8-7	20208070	
		900 700 860	TRE 9-7	20109070		TREP 9-7	20209070	
		1000 700 860	TRE 10-7	20110070		TREP 10-7	20210070	
		1100 700 860	TRE 11-7	20111070		TREP 11-7	20211070	
		1200 700 860	TRE 12-7	20112070		TREP 12-7	20212070	
		1300 700 860	TRE 13-7	20113070		TREP 13-7	20213070	
		1400 700 860	TRE 14-7	20114070		TREP 14-7	20214070	
		1500 700 860	TRE 15-7	20115070		TREP 15-7	20215070	
		1600 700 860	TRE 16-7	20116070		TREP 16-7	20216070	
		1700 700 860	TRE 17-7	20117070		TREP 17-7	20217070	
		1800 700 860	TRE 18-7	20118070		TREP 18-7	20218070	
		1900 700 860	TRE 19-7	20119070		TREP 19-7	20219070	
		2000 700 860	TRE 20-7	20120070		TREP 20-7	20220070	
		2100 700 860	TRE 21-7	20121070		TREP 21-7	20221070	
2200 700 860	TRE 22-7*	20122070		TREP 22-7*	20222070			
2300 700 860	TRE 23-7*	20123070		TREP 23-7*	20223070			
2400 700 860	TRE 24-7*	20124070		TREP 24-7*	20224070			
2500 700 860	TRE 25-7*	20125070		TREP 25-7*	20225070			
2600 700 860	TRE 26-7*	20126070		TREP 26-7*	20226070			

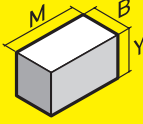
\* 6 πόδια - 6 legs

700		Διαστάσεις Dimensions (M x B x Y mm)	ΧΩΡΙΣ ΠΑΝΩΣΗΚΩΜΑ WITHOUT UPSTAND			ΜΕ ΠΑΝΩΣΗΚΩΜΑ WITH UPSTAND		
			Μοντέλο Model	Κωδικός Code	Τιμή € Price €	Μοντέλο Model	Κωδικός Code	Τιμή € Price €
Με δέσιμο 3 μεριές With 3 point frame	 	600 700 860	TRED 6-7	20306070		TREDP 6-7	20406070	
		700 700 860	TRED 7-7	20307070		TREDP 7-7	20407070	
		800 700 860	TRED 8-7	20308070		TREDP 8-7	20408070	
		900 700 860	TRED 9-7	20309070		TREDP 9-7	20409070	
		1000 700 860	TRED 10-7	20310070		TREDP 10-7	20410070	
		1100 700 860	TRED 11-7	20311070		TREDP 11-7	20411070	
		1200 700 860	TRED 12-7	20312070		TREDP 12-7	20412070	
		1300 700 860	TRED 13-7	20313070		TREDP 13-7	20413070	
		1400 700 860	TRED 14-7	20314070		TREDP 14-7	20414070	
		1500 700 860	TRED 15-7	20315070		TREDP 15-7	20415070	
		1600 700 860	TRED 16-7	20316070		TREDP 16-7	20416070	
		1700 700 860	TRED 17-7	20317070		TREDP 17-7	20417070	
		1800 700 860	TRED 18-7	20318070		TREDP 18-7	20418070	
		1900 700 860	TRED 19-7	20319070		TREDP 19-7	20419070	
		2000 700 860	TRED 20-7	20320070		TREDP 20-7	20420070	
		2100 700 860	TRED 21-7	20321070		TREDP 21-7	20421070	
2200 700 860	TRED 22-7*	20322070		TREDP 22-7*	20422070			
2300 700 860	TRED 23-7*	20323070		TREDP 23-7*	20423070			
2400 700 860	TRED 24-7*	20324070		TREDP 24-7*	20424070			
2500 700 860	TRED 25-7*	20325070		TREDP 25-7*	20425070			
2600 700 860	TRED 26-7*	20326070		TREDP 26-7*	20426070			

\* 6 πόδια - 6 legs

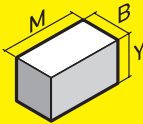
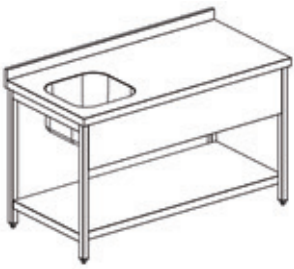

# ΤΡΑΠΕΖΙΑ ΕΡΓΑΣΙΑΣ ΜΕ ΓΟΥΡΝΑ

## WORK TABLES WITH SINK

700		Διαστάσεις	Μοντέλο	Κωδικός	Τιμή €
		Dimensions			
		(M x B x Y mm)			
Γούρνα 400x400, με πανωσήκωμα & κάτω ράφι Sink 400x400, with upstand & bottom shelf		1000 700 860	TREPG 10-7	20510070	
		1100 700 860	TREPG 11-7	20511070	
		1200 700 860	TREPG 12-7	20512070	
		1300 700 860	TREPG 13-7	20513070	
		1400 700 860	TREPG 14-7	20514070	
		1500 700 860	TREPG 15-7	20515070	
		1600 700 860	TREPG 16-7	20516070	
		1700 700 860	TREPG 17-7	20517070	
		1800 700 860	TREPG 18-7	20518070	
		1900 700 860	TREPG 19-7	20519070	
		2000 700 860	TREPG 20-7	20520070	
		2100 700 860	TREPG 21-7	20521070	

# ΚΑΤΩ ΚΑΙ ΜΕΣΑΙΑ ΡΑΦΙΑ

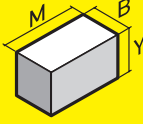
## BOTTOM AND MIDDLE SHELVES

700		Διαστάσεις	Μοντέλο	Κωδικός	Τιμή €
		Dimensions			
		(M x B x Y mm)			
Ράφι μετά λείανσης Smooth shelf		600 700 45	RF 6-7	20606070	
		700 700 45	RF 7-7	20607070	
		800 700 45	RF 8-7	20608070	
		900 700 45	RF 9-7	20609070	
		1000 700 45	RF 10-7	20610070	
		1100 700 45	RF 11-7	20611070	
		1200 700 45	RF 12-7	20612070	
		1300 700 45	RF 13-7	20613070	
		1400 700 45	RF 14-7	20614070	
		1500 700 45	RF 15-7	20615070	
		1600 700 45	RF 16-7	20616070	
		1700 700 45	RF 17-7	20617070	
		1800 700 45	RF 18-7	20618070	
		1900 700 45	RF 19-7	20619070	
		2000 700 45	RF 20-7	20620070	
		2100 700 45	RF 21-7	20621070	
		2200 700 45	RF 22-7	20622070	
2300 700 45	RF 23-7	20623070			
2400 700 45	RF 24-7	20624070			
2500 700 45	RF 25-7	20625070			
			RF 26-7	20626070	

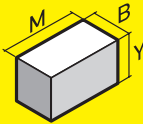
700 	Διαστάσεις Dimensions	Μοντέλο Model	Κωδικός Code	Τιμή € Price €
	(M x B x Y mm)			
Συρτάρι (Y=150 mm) Drawer (Y=150 mm)	450 700 150	ENS1 45-70	23104570	
	550 700 150	ENS1 55-70	23105570	

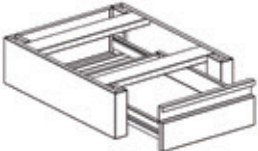

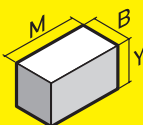
700 	Διαστάσεις Dimensions	Μοντέλο Model	Κωδικός Code	Τιμή € Price €
	(M x B x Y mm)			
Συρταριέρα με 2 συρτάρι 2-Drawer unit	450 700 590	ENS2 45-70	23204570	
	550 700 590	ENS2 55-70	23205570	

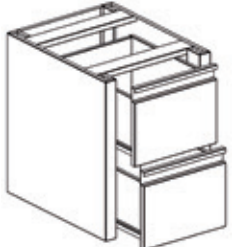

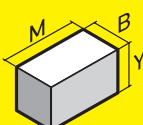
700 	Διαστάσεις Dimensions	Μοντέλο Model	Κωδικός Code	Τιμή € Price €
	(M x B x Y mm)			
Συρταριέρα με 3 συρτάρι 3-Drawer unit	450 700 590	ENS3 45-70	23304570	
	550 700 590	ENS3 55-70	23305570	

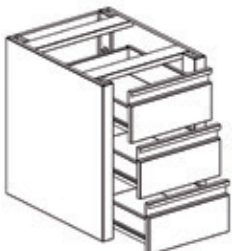

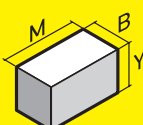
700 	Διαστάσεις Dimensions	Μοντέλο Model	Κωδικός Code	Τιμή € Price €
	(M x B x Y mm)			
Συρταριέρα με 4 συρτάρι 4-Drawer unit	450 700 590	ENS4 45-70	23404570	
	550 700 590	ENS4 55-70	23405570	

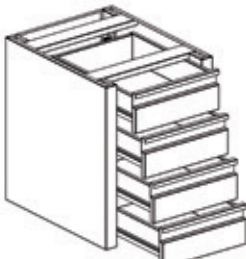

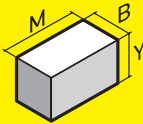
	Διαστάσεις Dimensions (M x B x Y mm)	Μοντέλο Model	Κωδικός Code	Τιμή € Price €
---	--	------------------	-----------------	-------------------

Κλειδαριά  
Lock



LCK

80000000

<b>700</b> 	Διαστάσεις Dimensions (M x B x Y mm)	Μοντέλο Model	Κωδικός Code	Τιμή € Price €
--	--	------------------	-----------------	-------------------

Σκελετός για GN  
Cabinet for gastronomie

380 **700** 590  
580 **380** 590

SKL GN 1/1  
SKL GN 2/1

23603870  
23605838W



<b>700</b> 	Διαστάσεις Dimensions (M x B x Y mm)	Μοντέλο Model	Κωδικός Code	Τιμή € Price €
--	--	------------------	-----------------	-------------------

Αμπάρι  
Hopper

450 **700** 590  
550 **700** 590

ABE 4-7  
ABE 5-7

23404570  
23405570



<b>700</b> 	Διαστάσεις Dimensions (M x B x Y mm)	Μοντέλο Model	Κωδικός Code	Τιμή € Price €
--	--	------------------	-----------------	-------------------

Αμπάρι με συρτάρι  
Hopper with drawer

450 **700** 590  
550 **700** 590



SABE 4-7  
SABE 5-7

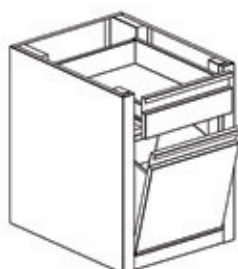

23504570  
23505570

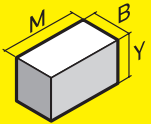

600		Διαστάσεις Dimensions (M x B x Y mm)	ΧΩΡΙΣ ΠΑΝΩΣΗΚΩΜΑ WITHOUT UPSTAND			ΜΕ ΠΑΝΩΣΗΚΩΜΑ WITH UPSTAND		
			Μοντέλο Model	Κωδικός Code	Τιμή € Price €	Μοντέλο Model	Κωδικός Code	Τιμή € Price €
Ανοιχτό με ενδιάμεσο ράφι Open with middle shelf		600 600 860	ERA 6-6	00106060		ERAP 6-6	00206060	
		700 600 860	ERA 7-6	00107060		ERAP 7-6	00207060	
		800 600 860	ERA 8-6	00108060		ERAP 8-6	00208060	
		900 600 860	ERA 9-6	00109060		ERAP 9-6	00209060	
		1000 600 860	ERA 10-6	00110060		ERAP 10-6	00210060	
		1100 600 860	ERA 11-6	00111060		ERAP 11-6	00211060	
		1200 600 860	ERA 12-6	00112060		ERAP 12-6	00212060	
		1300 600 860	ERA 13-6	00113060		ERAP 13-6	00213060	
		1400 600 860	ERA 14-6	00114060		ERAP 14-6	00214060	
		1500 600 860	ERA 15-6	00115060		ERAP 15-6	00215060	
		1600 600 860	ERA 16-6	00116060		ERAP 16-6	00216060	
		1700 600 860	ERA 17-6	00117060		ERAP 17-6	00217060	
		1800 600 860	ERA 18-6	00118060		ERAP 18-6	00218060	
		1900 600 860	ERA 19-6	00119060		ERAP 19-6	00219060	
		2000 600 860	ERA 20-6	00120060		ERAP 20-6	00220060	
		2100 600 860	ERA 21-6	00121060		ERAP 21-6	00221060	
		2200 600 860	ERA 22-6	00122060		ERAP 22-6	00222060	
		2300 600 860	ERA 23-6	00123060		ERAP 23-6	00223060	
		2400 600 860	ERA 24-6	00124060		ERAP 24-6	00224060	

600		Διαστάσεις Dimensions (M x B x Y mm)	ΧΩΡΙΣ ΠΑΝΩΣΗΚΩΜΑ WITHOUT UPSTAND			ΜΕ ΠΑΝΩΣΗΚΩΜΑ WITH UPSTAND		
			Μοντέλο Model	Κωδικός Code	Τιμή € Price €	Μοντέλο Model	Κωδικός Code	Τιμή € Price €
Με συρόμενες πόρτες With sliding doors		1000 600 860	SYM 10-6	00310060		SYMP 10-6	00410060	
		1100 600 860	SYM 11-6	00311060		SYMP 11-6	00411060	
		1200 600 860	SYM 12-6	00312060		SYMP 12-6	00412060	
		1300 600 860	SYM 13-6	00313060		SYMP 13-6	00413060	
		1400 600 860	SYM 14-6	00314060		SYMP 14-6	00414060	
		1500 600 860	SYM 15-6	00315060		SYMP 15-6	00415060	
		1600 600 860	SYM 16-6	00316060		SYMP 16-6	00416060	
		1700 600 860	SYM 17-6	00317060		SYMP 17-6	00417060	
		1800 600 860	SYM 18-6	00318060		SYMP 18-6	00418060	
		1900 600 860	SYM 19-6	00319060		SYMP 19-6	00419060	
		2000 600 860	SYM 20-6	00320060		SYMP 20-6	00420060	
		2100 600 860	SYM 21-6	00321060		SYMP 21-6	00421060	
		2200 600 860	SYM 22-6	00322060		SYMP 22-6	00422060	
		2300 600 860	SYM 23-6	00323060		SYMP 23-6	00423060	
		2400 600 860	SYM 24-6	00324060		SYMP 24-6	00424060	

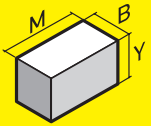
600		Διαστάσεις Dimensions (M x B x Y mm)	Μοντέλο Model	Κωδικός Code	Τιμή € Price €
Αμπάρι Hopper		500 600 860	ERABA 5-6	02405060	

600		Διαστάσεις Dimensions (M x B x Y mm)	Μοντέλο Model	Κωδικός Code	Τιμή € Price €
Συρταριέρα Drawer unit		500 600 860	<b>Με 3 συρτάρια - With 3 drawers</b>		
			ER3S 5-6	02505060	
			<b>Με 4 συρτάρια - With 4 drawers</b>		
			ER4S 5-6	02605060	

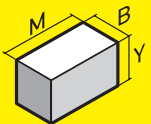
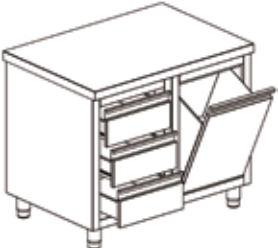
600		Διαστάσεις Dimensions (M x B x Y mm)	Μοντέλο Model	Κωδικός Code	Τιμή € Price €
Αμπάρι & 3πλή συρταριέρα Hopper with 3-Drawer unit		1000 600 860	ERA3S 10-6	02710060	

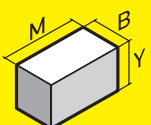
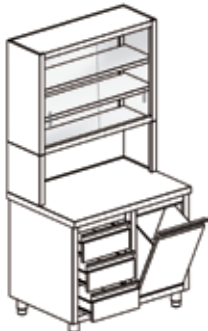
600		Διαστάσεις Dimensions (M x B x Y mm)	Μοντέλο Model	Κωδικός Code	Τιμή € Price €
		1000 600 1940	ERA3SPTR 10-6	02810060	
			Αμπάρι, συρταριέρα & ένθετη ποτηριέρα Hopper, 3-Drawer unit & wall cupboard		

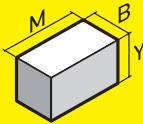
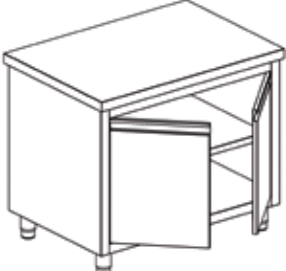
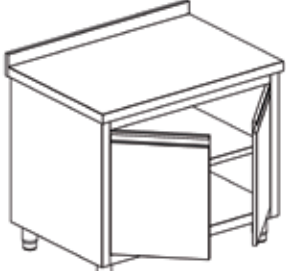
600 	Διαστάσεις Dimensions (M x B x Y mm)	ΧΩΡΙΣ ΠΑΝΩΣΗΚΩΜΑ WITHOUT UPSTAND			ΜΕ ΠΑΝΩΣΗΚΩΜΑ WITH UPSTAND		
		Μοντέλο Model	Κωδικός Code	Τιμή € Price €	Μοντέλο Model	Κωδικός Code	Τιμή € Price €
<p>Με ανοιγόμενες πόρτες With hinged doors</p>   <p>* 1 πόρτα - 1 door</p>	300 600 860	ANM 3-6*	00503060		ANP 3-6*	00603060	
	400 600 860	ANM 4-6*	00504060		ANP 4-6*	00604060	
	500 600 860	ANM 5-6*	00505060		ANP 5-6*	00605060	
	600 600 860	ANM 6-6*	00506060		ANP 6-6*	00606060	
	700 600 860	ANM 7-6	00507060		ANP 7-6	00607060	
	800 600 860	ANM 8-6	00508060		ANP 8-6	00608060	
	900 600 860	ANM 9-6	00509060		ANP 9-6	00609060	
	1000 600 860	ANM 10-6	00510060		ANP 10-6	00610060	
	1330 600 860	ANM 13-6	00513360		ANP 13-6	00613360	
	1770 600 860	ANM 17-6	00517760		ANP 17-6	00617760	
	2050 600 860	ANM 20-6	00520560		ANP 20-6	00620560	

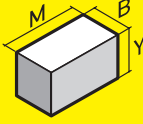
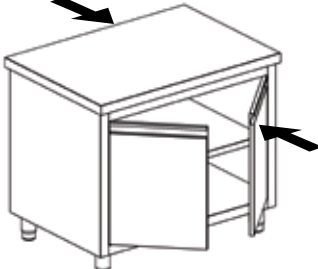
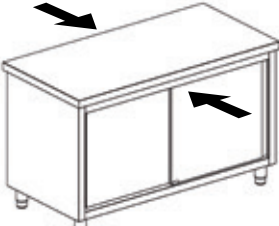

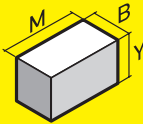
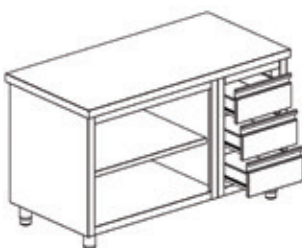
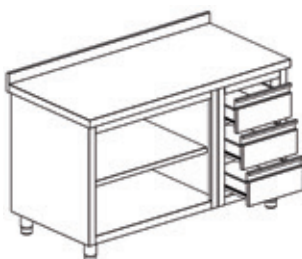
600 	Διαστάσεις Dimensions (M x B x Y mm)	Μοντέλο Model	Κωδικός Code	Τιμή € Price €
<p>Με ανοιγόμενες πόρτες - 2 μεριές With 2-side hinged doors</p> 	<b>Με 2 ανοιγόμενες πόρτες - With 2 hinged doors</b>			
	800 600 860	AN2M 8-6	00708060	
	900 600 860	AN2M 9-6	00709060	
<p>Με συρόμενες πόρτες - 2 μεριές With 2-side sliding doors</p> 	<b>Με 2 συρόμενες πόρτες - With 2 sliding doors</b>			
	1000 600 860	SY2M 10-6	00810060	
	1100 600 860	SY2M 11-6	00811060	
	1200 600 860	SY2M 12-6	00812060	
	1300 600 860	SY2M 13-6	00813060	
	1400 600 860	SY2M 14-6	00814060	
	1500 600 860	SY2M 15-6	00815060	
	1600 600 860	SY2M 16-6	00816060	
	1700 600 860	SY2M 17-6	00817060	
	1800 600 860	SY2M 18-6	00818060	
1900 600 860	SY2M 19-6	00819060		
2000 600 860	SY2M 20-6	00820060		
2100 600 860	SY2M 21-6	00821060		
2200 600 860	SY2M 22-6	00822060		

600		<b>Διαστάσεις</b> <b>Dimensions</b> (M x B x Y mm)	ΧΩΡΙΣ ΠΑΝΩΣΗΚΩΜΑ WITHOUT UPSTAND			ΜΕ ΠΑΝΩΣΗΚΩΜΑ WITH UPSTAND			
			Μοντέλο Model	Κωδικός Code	Τιμή € Price €	Μοντέλο Model	Κωδικός Code	Τιμή € Price €	
<b>Ανοικτό</b> <b>με συρταριέρα δεξιά</b> Open with drawer unit on right	  	800 600 860	ERS 8-6	00908060	800,00	ERSP 8-6	01008060		
		900 600 860	ERS 9-6	00909060	800,00	ERSP 9-6	01009060		
		1000 600 860	ERS 10-6	00910060	867,00	ERSP 10-6	01010060		
		1100 600 860	ERS 11-6	00911060	867,00	ERSP 11-6	01011060		
		1200 600 860	ERS 12-6	00912060	912,00	ERSP 12-6	01012060		
		1300 600 860	ERS 13-6	00913060	957,00	ERSP 13-6	01013060		
		1400 600 860	ERS 14-6	00914060	1002,00	ERSP 14-6	01014060		
		1500 600 860	ERS 15-6	00915060	1047,00	ERSP 15-6	01015060		
		1600 600 860	ERS 16-6	00916060	1065,00	ERSP 16-6	01016060		
		1700 600 860	ERS 17-6	00917060	1084,00	ERSP 17-6	01017060		
		1800 600 860	ERS 18-6	00918060	1115,00	ERSP 18-6	01018060		
		1900 600 860	ERS 19-6	00919060	1145,00	ERSP 19-6	01019060		
		2000 600 860	ERS 20-6	00920060	1177,00	ERSP 20-6	01020060		
		2100 600 860	ERS 21-6	00921060	1207,00	ERSP 21-6	01021060		
		2200 600 860	ERS 22-6	00922060	1237,00	ERSP 22-6	01022060		

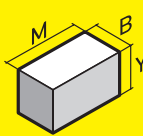
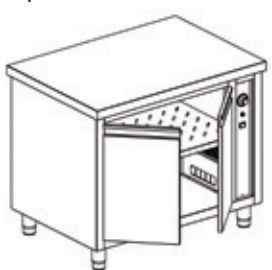
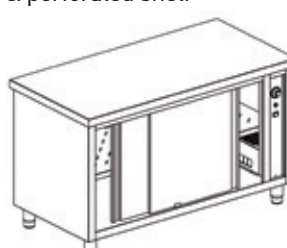

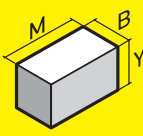
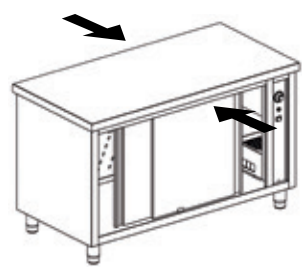
600		Διαστάσεις Dimensions (M x B x Y mm)	ΧΩΡΙΣ ΠΑΝΩΣΗΚΩΜΑ WITHOUT UPSTAND			ΜΕ ΠΑΝΩΣΗΚΩΜΑ WITH UPSTAND		
			Μοντέλο Model	Κωδικός Code	Τιμή € Price €	Μοντέλο Model	Κωδικός Code	Τιμή € Price €
<b>Με ανοιγόμενες πόρτες &amp; διάτρητο ράφι</b> With hinged doors & perforated shelf								
								
<b>Με συρόμενες πόρτες &amp; διάτρητο ράφι</b> With sliding doors & perforated shelf								
								
<b>Με 2 ανοιγόμενες πόρτες - With 2 hinged doors</b>								
600	600	860	THA 6-6	01606060		THAP 6-6	01706060	
700	600	860	THA 7-6	01607060		THAP 7-6	01707060	
800	600	860	THA 8-6	01608060		THAP 8-6	01708060	
900	600	860	THA 9-6	01609060		THAP 9-6	01709060	
<b>Με 2 συρόμενες πόρτες - With 2 sliding doors</b>								
1000	600	860	THS 10-6	01810060		THSP 10-6	01910060	
1100	600	860	THS 11-6	01811060		THSP 11-6	01911060	
1200	600	860	THS 12-6	01812060		THSP 12-6	01912060	
1300	600	860	THS 13-6	01813060		THSP 13-6	01913060	
1400	600	860	THS 14-6	01814060		THSP 14-6	01914060	
1500	600	860	THS 15-6	01815060		THSP 15-6	01915060	
1600	600	860	THS 16-6	01816060		THSP 16-6	01916060	
1700	600	860	THS 17-6	01817060		THSP 17-6	01917060	
1800	600	860	THS 18-6	01818060		THSP 18-6	01918060	

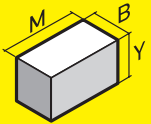
600		Διαστάσεις Dimensions (M x B x Y mm)	Μοντέλο Model	Κωδικός Code	Τιμή € Price €
<b>Με συρόμενες πόρτες - 2 μεριές &amp; διάτρητο ράφι</b> With 2-side sliding doors & perforated shelf					
					
1200	600	860	TH2S 12-6	02012060	
1300	600	860	TH2S 13-6	02013060	
1400	600	860	TH2S 14-6	02014060	
1500	600	860	TH2S 15-6	02015060	
1600	600	860	TH2S 16-6	02016060	
1700	600	860	TH2S 17-6	02017060	
1800	600	860	TH2S 18-6	02018060	
1900	600	860	TH2S 19-6	02019060	
2000	600	860	TH2S 20-6	02020060	
2100	600	860	TH2S 21-6	02021060	
2200	600	860	TH2S 22-6	02022060	

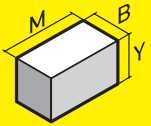
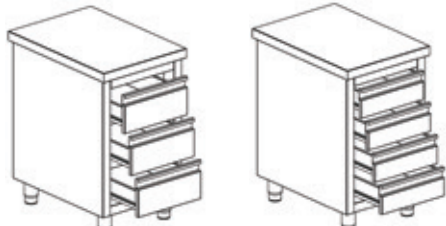

700		Διαστάσεις Dimensions (M x B x Y mm)	Μοντέλο Model	Κωδικός Code	Τιμή € Price €
Αμμάρι Hopper		500 700 860	ERABA 5-7	02405070	

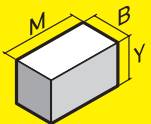
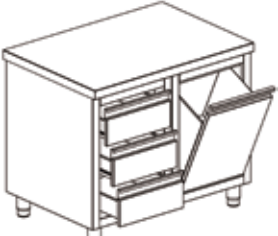
700		Διαστάσεις Dimensions (M x B x Y mm)	Μοντέλο Model	Κωδικός Code	Τιμή € Price €
Συρταριέρα Drawer unit		500 700 860	<b>Με 3 συρτάρια - With 3 drawers</b>		
			ER3S 5-7	02505070	
			<b>Με 4 συρτάρια - With 4 drawers</b>		
			ER4S 5-7	02605070	

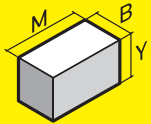

700		Διαστάσεις Dimensions (M x B x Y mm)	Μοντέλο Model	Κωδικός Code	Τιμή € Price €
Αμμάρι & 3πλή συρταριέρα Hopper with 3-Drawer unit		1000 700 860	ERA3S 10-7	02710070	

700		Διαστάσεις Dimensions (M x B x Y mm)	Μοντέλο Model	Κωδικός Code	Τιμή € Price €
		1000 700 1940	ERA3SPTR 10-7	02810070	

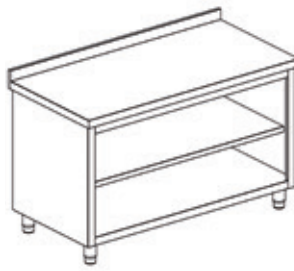
Αμμάρι, συρταριέρα & ένθετη ποτηριέρα  
Hopper, 3-Drawer unit & wall cupboard

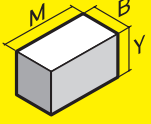
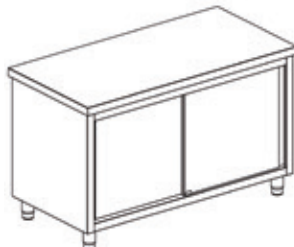
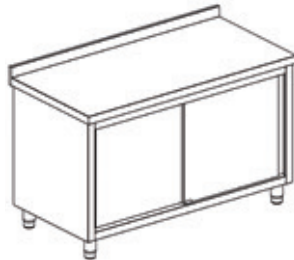
700		Διαστάσεις Dimensions (M x B x Y mm)	ΧΩΡΙΣ ΠΑΝΩΣΗΚΩΜΑ WITHOUT UPSTAND			ΜΕ ΠΑΝΩΣΗΚΩΜΑ WITH UPSTAND			
			Μοντέλο Model	Κωδικός Code	Τιμή € Price €	Μοντέλο Model	Κωδικός Code	Τιμή € Price €	
<p>Ανοιχτό με ενδιάμεσο ράφι Open with middle shelf</p>  	600	700	860	ERA 6-7	00106070		ERAP 6-7	00206070	
	700	700	860	ERA 7-7	00107070		ERAP 7-7	00207070	
	800	700	860	ERA 8-7	00108070		ERAP 8-7	00208070	
	900	700	860	ERA 9-7	00109070		ERAP 9-7	00209070	
	1000	700	860	ERA 10-7	00110070		ERAP 10-7	00210070	
	1100	700	860	ERA 11-7	00111070		ERAP 11-7	00211070	
	1200	700	860	ERA 12-7	00112070		ERAP 12-7	00212070	
	1300	700	860	ERA 13-7	00113070		ERAP 13-7	00213070	
	1400	700	860	ERA 14-7	00114070		ERAP 14-7	00214070	
	1500	700	860	ERA 15-7	00115070		ERAP 15-7	00215070	
	1600	700	860	ERA 16-7	00116070		ERAP 16-7	00216070	
	1700	700	860	ERA 17-7	00117070		ERAP 17-7	00217070	
	1800	700	860	ERA 18-7	00118070		ERAP 18-7	00218070	
	1900	700	860	ERA 19-7	00119070		ERAP 19-7	00219070	
	2000	700	860	ERA 20-7	00120070		ERAP 20-7	00220070	
	2100	700	860	ERA 21-7	00121070		ERAP 21-7	00221070	
	2200	700	860	ERA 22-7	00122070		ERAP 22-7	00222070	
	2300	700	860	ERA 23-7	00123070		ERAP 23-7	00223070	
	2400	700	860	ERA 24-7	00124070		ERAP 24-7	00224070	

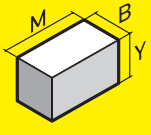
700		Διαστάσεις Dimensions (M x B x Y mm)	ΧΩΡΙΣ ΠΑΝΩΣΗΚΩΜΑ WITHOUT UPSTAND			ΜΕ ΠΑΝΩΣΗΚΩΜΑ WITH UPSTAND			
			Μοντέλο Model	Κωδικός Code	Τιμή € Price €	Μοντέλο Model	Κωδικός Code	Τιμή € Price €	
<p>Με συρόμενες πόρτες With sliding doors</p>  	1000	700	860	SYM 10-7	00310070		SYMP 10-7	00410070	
	1100	700	860	SYM 11-7	00311070		SYMP 11-7	00411070	
	1200	700	860	SYM 12-7	00312070		SYMP 12-7	00412070	
	1300	700	860	SYM 13-7	00313070		SYMP 13-7	00413070	
	1400	700	860	SYM 14-7	00314070		SYMP 14-7	00414070	
	1500	700	860	SYM 15-7	00315070		SYMP 15-7	00415070	
	1600	700	860	SYM 16-7	00316070		SYMP 16-7	00416070	
	1700	700	860	SYM 17-7	00317070		SYMP 17-7	00417070	
	1800	700	860	SYM 18-7	00318070		SYMP 18-7	00418070	
	1900	700	860	SYM 19-7	00319070		SYMP 19-7	00419070	
	2000	700	860	SYM 20-7	00320070		SYMP 20-7	00420070	
	2100	700	860	SYM 21-7	00321070		SYMP 21-7	00421070	
	2200	700	860	SYM 22-7	00322070		SYMP 22-7	00422070	
	2300	700	860	SYM 23-7	00323070		SYMP 23-7	00423070	
	2400	700	860	SYM 24-7	00324070		SYMP 24-7	00424070	

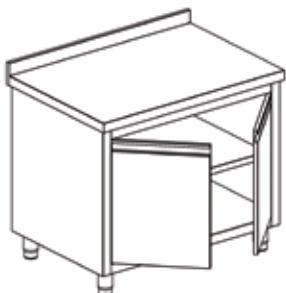
700		Διαστάσεις Dimensions (M x B x Y mm)	ΧΩΡΙΣ ΠΑΝΩΣΗΚΩΜΑ WITHOUT UPSTAND			ΜΕ ΠΑΝΩΣΗΚΩΜΑ WITH UPSTAND			
			Μοντέλο Model	Κωδικός Code	Τιμή € Price €	Μοντέλο Model	Κωδικός Code	Τιμή € Price €	
<b>Με ανοιγόμενες πόρτες</b> With hinged doors      * 1 πόρτα - 1 door ** 2 πόρτες - 2 doors *** 3 πόρτες - 3 doors **** 4 πόρτες - 4 doors	300	700	860	ANM 3-7*	00503070		ANP 3-7*	00603070	
	400	700	860	ANM 4-7*	00504070		ANP 4-7*	00604070	
	500	700	860	ANM 5-7*	00505070		ANP 5-7*	00605070	
	600	700	860	ANM 6-7*	00506070		ANP 6-7*	00606070	
	700	700	860	ANM 7-7**	00507070		ANP 7-7**	00607070	
	800	700	860	ANM 8-7**	00508070		ANP 8-7**	00608070	
	900	700	860	ANM 9-7**	00509070		ANP 9-7**	00609070	
	1000	700	860	ANM 10-7**	00510070		ANP 10-7**	00610070	
	1330	700	860	ANM 13-7***	00513370		ANP 13-7***	00613370	
	1770	700	860	ANM 17-7****	00517770		ANP 17-7****	00617770	
	2050	700	860	ANM 20-7****	00520570		ANP 20-7****	00620570	

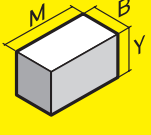
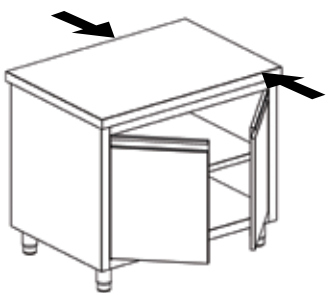
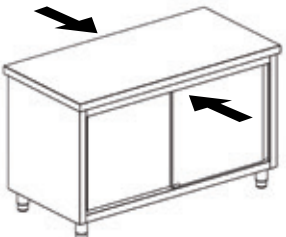
700		Διαστάσεις Dimensions (M x B x Y mm)	Μοντέλο Model	Κωδικός Code	Τιμή € Price €
			<b>Με 2 ανοιγόμενες πόρτες - With 2 hinged doors</b>		
<b>Με ανοιγόμενες πόρτες - 2 μεριές</b> With 2-side hinged doors  	800	700	860	AN2M 8-7	00708070
	900	700	860	AN2M 9-7	00709070
<b>Με 2 συρόμενες πόρτες - With 2 sliding doors</b>					
<b>Με συρόμενες πόρτες - 2 μεριές</b> With 2-side sliding doors  	1000	700	860	SY2M 10-7	00810070
	1100	700	860	SY2M 11-7	00811070
	1200	700	860	SY2M 12-7	00812070
	1300	700	860	SY2M 13-7	00813070
	1400	700	860	SY2M 14-7	00814070
	1500	700	860	SY2M 15-7	00815070
	1600	700	860	SY2M 16-7	00816070
	1700	700	860	SY2M 17-7	00817070
	1800	700	860	SY2M 18-7	00818070
	1900	700	860	SY2M 19-7	00819070
	2000	700	860	SY2M 20-7	00820070
2100	700	860	SY2M 21-7	00821070	
2200	700	860	SY2M 22-7	00822070	

700		Διαστάσεις Dimensions (M x B x Y mm)	ΧΩΡΙΣ ΠΑΝΩΣΗΚΩΜΑ WITHOUT UPSTAND			ΜΕ ΠΑΝΩΣΗΚΩΜΑ WITH UPSTAND		
			Μοντέλο Model	Κωδικός Code	Τιμή € Price €	Μοντέλο Model	Κωδικός Code	Τιμή € Price €
Ανοιχτό με συρταριέρα δεξιά Open with drawer unit on right		800 700 860	ERS 8-7	00908070	800,00	ERSP 8-7	01008070	842,00
		900 700 860	ERS 9-7	00909070	800,00	ERSP 9-7	01009070	842,00
		1000 700 860	ERS 10-7	00910070	867,00	ERSP 10-7	01010070	909,00
		1100 700 860	ERS 11-7	00911070	867,00	ERSP 11-7	01011070	909,00
		1200 700 860	ERS 12-7	00912070	912,00	ERSP 12-7	01012070	954,00
		1300 700 860	ERS 13-7	00913070	957,00	ERSP 13-7	01013070	999,00
		1400 700 860	ERS 14-7	00914070	1002,00	ERSP 14-7	01014070	1054,00
		1500 700 860	ERS 15-7	00915070	1047,00	ERSP 15-7	01015070	1089,00
		1600 700 860	ERS 16-7	00916070	1065,00	ERSP 16-7	01016070	1107,00
		1700 700 860	ERS 17-7	00917070	1084,00	ERSP 17-7	01017070	1125,00
		1800 700 860	ERS 18-7	00918070	1115,00	ERSP 18-7	01018070	1157,00
		1900 700 860	ERS 19-7	00919070	1145,00	ERSP 19-7	01019070	1187,00
2000 700 860	ERS 20-7	00920070	1177,00	ERSP 20-7	01020070	1219,00		
2100 700 860	ERS 21-7	00921070	1207,00	ERSP 21-7	01021070	1249,00		
2200 700 860	ERS 22-7	00922070	1237,00	ERSP 22-7	01022070	1279,00		

700		Διαστάσεις Dimensions (M x B x Y mm)	ΧΩΡΙΣ ΠΑΝΩΣΗΚΩΜΑ WITHOUT UPSTAND			ΜΕ ΠΑΝΩΣΗΚΩΜΑ WITH UPSTAND		
			Μοντέλο Model	Κωδικός Code	Τιμή € Price €	Μοντέλο Model	Κωδικός Code	Τιμή € Price €
Με συρόμενες πόρτες & συρταρία κατά μήκος With sliding doors & horizontal drawers		<b>Με 2 συρτάρια - With 2 drawers</b>						
		1000 700 860	SM2S 10-7	02110070		SM2SP 10-7	02210070	
		1100 700 860	SM2S 11-7	02111070		SM2SP 11-7	02211070	
		1200 700 860	SM2S 12-7	02112070		SM2SP 12-7	02212070	
		<b>Με 3 συρτάρια - With 3 drawers</b>						
		1300 700 860	SM3S 13-7	02113070		SM3SP 13-7	02213070	
		1400 700 860	SM3S 14-7	02114070		SM3SP 14-7	02214070	
		1500 700 860	SM3S 15-7	02115070		SM3SP 15-7	02215070	
		1600 700 860	SM3S 16-7	02116070		SM3SP 16-7	02216070	
		<b>Με 4 συρτάρια - With 4 drawers</b>						
		1700 700 860	SM4S 17-7	02117070		SM4SP 17-7	02217070	
		1800 700 860	SM4S 18-7	02118070		SM4SP 18-7	02218070	
1900 700 860	SM4S 19-7	02119070		SM4SP 19-7	02219070			
2000 700 860	SM4S 20-7	02120070		SM4SP 20-7	02220070			
<b>Με 5 συρτάρια - With 5 drawers</b>								
2100 700 860	SM5S 21-7	02121070		SM5SP 21-7	02221070			

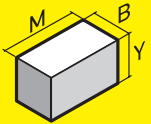
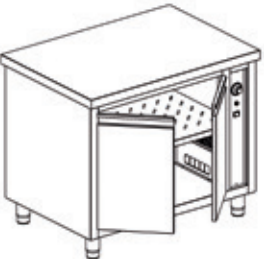
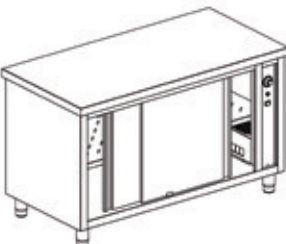

700		Διαστάσεις Dimensions (M x B x Y mm)	ΧΩΡΙΣ ΠΑΝΩΣΗΚΩΜΑ WITHOUT UPSTAND			ΜΕ ΠΑΝΩΣΗΚΩΜΑ WITH UPSTAND		
			Μοντέλο Model	Κωδικός Code	Τιμή € Price €	Μοντέλο Model	Κωδικός Code	Τιμή € Price €
<b>Με ανοιγόμενες πόρτες &amp; διάτρητο ράφι</b> With hinged doors & perforated shelf								
								
<b>Με 2 ανοιγόμενες πόρτες - With 2 hinged doors</b>								
600	700	860	THA 6-7	01606070		THAP 6-7	01706070	
700	700	860	THA 7-7	01607070		THAP 7-7	01707070	
800	700	860	THA 8-7	01608070		THAP 8-7	01708070	
900	700	860	THA 9-7	01609070		THAP 9-7	01709070	
<b>Με 2 συρόμενες πόρτες - With 2 sliding doors</b>								
								
1000	700	860	THS 10-7	01810070		THSP 10-7	01910070	
1100	700	860	THS 11-7	01811070		THSP 11-7	01911070	
1200	700	860	THS 12-7	01812070		THSP 12-7	01912070	
1300	700	860	THS 13-7	01813070		THSP 13-7	01913070	
1400	700	860	THS 14-7	01814070		THSP 14-7	01914070	
1500	700	860	THS 15-7	01815070		THSP 15-7	01915070	
1600	700	860	THS 16-7	01816070		THSP 16-7	01916070	
1700	700	860	THS 17-7	01817070		THSP 17-7	01917070	
1800	700	860	THS 18-7	01818070		THSP 18-7	01918070	

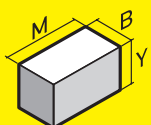
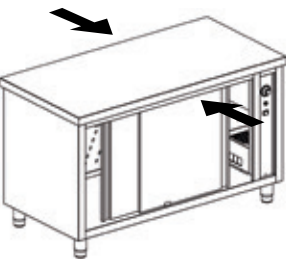
700		Διαστάσεις Dimensions (M x B x Y mm)	Μοντέλο Model	Κωδικός Code	Τιμή € Price €
<b>Με συρόμενες πόρτες - 2 μεριές &amp; διάτρητο ράφι</b> With 2-side sliding doors & perforated shelf					
					
1200	700	860	TH2S 12-7	02012070	
1300	700	860	TH2S 13-7	02013070	
1400	700	860	TH2S 14-7	02014070	
1500	700	860	TH2S 15-7	02015070	
1600	700	860	TH2S 16-7	02016070	
1700	700	860	TH2S 17-7	02017070	
1800	700	860	TH2S 18-7	02018070	
1900	700	860	TH2S 19-7	02019070	
2000	700	860	TH2S 20-7	02020070	
2100	700	860	TH2S 21-7	02021070	
2200	700	860	TH2S 22-7	02022070	

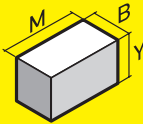
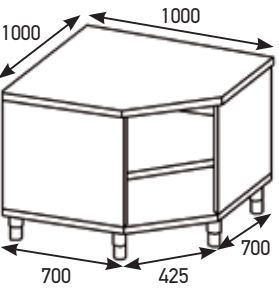
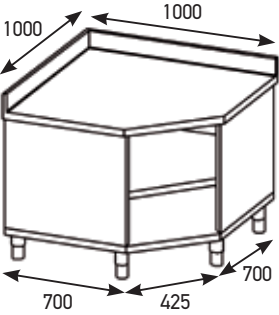
700 	Διαστάσεις Dimensions (M x B x Y mm)	ΧΩΡΙΣ ΠΑΝΩΣΗΚΩΜΑ WITHOUT UPSTAND			ΜΕ ΠΑΝΩΣΗΚΩΜΑ WITH UPSTAND		
		Μοντέλο Model	Κωδικός Code	Τιμή € Price €	Μοντέλο Model	Κωδικός Code	Τιμή € Price €
<b>Γωνιακού τύπου, ανοιχτό</b> Corner type, open    	1000 700 860	ERAGON 10-7	02010070		ERAGONP 10-7	02110070	
	1100 700 860	ERAGON 11-7	02011070		ERAGONP 11-7	02111070	

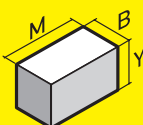
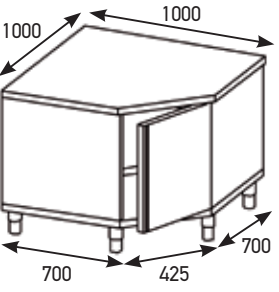
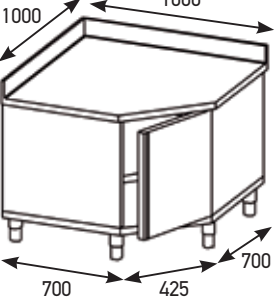
700 	Διαστάσεις Dimensions (M x B x Y mm)	ΧΩΡΙΣ ΠΑΝΩΣΗΚΩΜΑ WITHOUT UPSTAND			ΜΕ ΠΑΝΩΣΗΚΩΜΑ WITH UPSTAND		
		Μοντέλο Model	Κωδικός Code	Τιμή € Price €	Μοντέλο Model	Κωδικός Code	Τιμή € Price €
<b>Γωνιακού τύπου με ανοιγόμενες πόρτες</b> Corner type with hinged doors    	1000 700 860	ERAGONA 10-7	02210070		ERAGONAP 10-7	02310070	
	1100 700 860	ERAGONA 11-7	02211070		ERAGONAP 11-7	02311070	

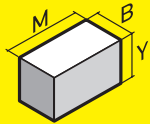
	<b>Διαστάσεις</b> <b>Dimensions</b> (M x B x Y mm)	<b>Μοντέλο</b> <b>Model</b>	<b>Κωδικός</b> <b>Code</b>	<b>Τιμή €</b> <b>Price €</b>
---	--	--------------------------------	-------------------------------	---------------------------------

Κλειδαριά  
 Lock



LCK

80000000

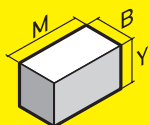
<b>700</b>		<b>Διαστάσεις</b> <b>Dimensions</b> (M x B x Y mm)	<b>Μοντέλο</b> <b>Model</b>	<b>Κωδικός</b> <b>Code</b>	<b>Τιμή ανά</b> <b>τεμάχιο €</b> <b>Price</b> <b>per item €</b>
------------	---	--	--------------------------------	-------------------------------	--

Ρόδες - Χρώμιο  
 Wheels - Chromed steel



**Με φρένο - With Brake**

WH-CRB 2-2



81000000

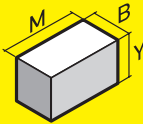
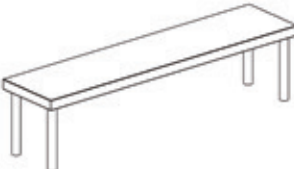

**Χωρίς φρένο - Without Brake**

WH-CR 2-2

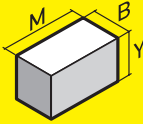
82000000

330 	Διαστάσεις Dimensions	Μοντέλο Model	Κωδικός Code	Τιμή € Price €
	(M x B x Y mm)			
<b>Μονό επιτραπέζιο ράφι με σωλήνα Φ40</b> 1-tier overshef with Φ40 legs  	400 330 350	REPM 4-3	03004033	
	600 330 350	REPM 6-3	03006033	
	800 330 350	REPM 8-3	03008033	
	1000 330 350	REPM 10-3	03010033	
	1200 330 350	REPM 12-3	03012033	
	1400 330 350	REPM 14-3	03014033	
	1600 330 350	REPM 16-3	03016033	
	1800 330 350	REPM 18-3	03018033	
	2000 330 350	REPM 20-3	03020033	
	2200 330 350	REPM 22-3	03022033	
	2400 330 350	REPM 24-3	03024033	
2600 330 350	REPM 26-3	03026033		

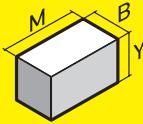

330 	Διαστάσεις Dimensions	Μοντέλο Model	Κωδικός Code	Τιμή € Price €
	(M x B x Y mm)			
<b>Διπλό επιτραπέζιο ράφι με σωλήνα Φ40</b> 2-tier overshef with Φ40 legs  	400 330 700	REPD 4-3	03104033	
	600 330 700	REPD 6-3	03106033	
	800 330 700	REPD 8-3	03108033	
	1000 330 700	REPD 10-3	03110033	
	1200 330 700	REPD 12-3	03112033	
	1400 330 700	REPD 14-3	03114033	
	1600 330 700	REPD 16-3	03116033	
	1800 330 700	REPD 18-3	03118033	
	2000 330 700	REPD 20-3	03120033	
	2200 330 700	REPD 22-3	03122033	
	2400 330 700	REPD 24-3	03124033	
2600 330 700	REPD 26-3	03126033		

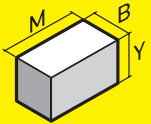
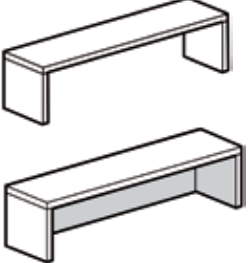
330 	Διαστάσεις Dimensions	Μοντέλο Model	Κωδικός Code	Τιμή € Price €
	(M x B x Y mm)			
<b>Τριπλό επιτραπέζιο ράφι με σωλήνα Φ40</b> 3-tier overshef with Φ40 legs  	400 330 1100	REPT 4-3	03204033	
	600 330 1100	REPT 6-3	03206033	
	800 330 1100	REPT 8-3	03208033	
	1000 330 1100	REPT 10-3	03210033	
	1200 330 1100	REPT 12-3	03212033	
	1400 330 1100	REPT 14-3	03214033	
	1600 330 1100	REPT 16-3	03216033	
	1800 330 1100	REPT 18-3	03218033	
	2000 330 1100	REPT 20-3	03220033	
	2200 330 1100	REPT 22-3	03222033	
	2400 330 1100	REPT 24-3	03224033	
2600 330 1100	REPT 26-3	03226033		

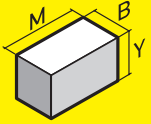
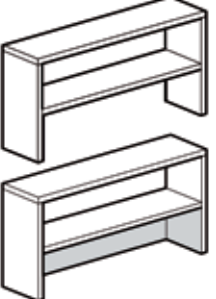
330		Διαστάσεις Dimensions (M x B x Y mm)	ΑΝΟΙΧΤΗ ΠΛΑΤΗ OPEN BACKWALL			ΚΛΕΙΣΤΗ ΠΛΑΤΗ CLOSED BACKWALL					
			Μοντέλο Model	Κωδικός Code	Τιμή € Price €	Μοντέλο Model	Κωδικός Code	Τιμή € Price €			
<b>1-επιπέδου ράφι με κλειστά πλαινά</b> 1-tier overshelf with side closed 			1000	330	350	PEPAM 10-3	02910033		PEPKM 10-3	03310033	
			1100	330	350	PEPAM 11-3	02911033		PEPKM 11-3	03311033	
			1200	330	350	PEPAM 12-3	02912033		PEPKM 12-3	03312033	
			1300	330	350	PEPAM 13-3	02913033		PEPKM 13-3	03313033	
			1400	330	350	PEPAM 14-3	02914033		PEPKM 14-3	03314033	
			1500	330	350	PEPAM 15-3	02915033		PEPKM 15-3	03315033	
			1600	330	350	PEPAM 16-3	02916033		PEPKM 16-3	03316033	
			1700	330	350	PEPAM 17-3	02917033		PEPKM 17-3	03317033	
			1800	330	350	PEPAM 18-3	02918033		PEPKM 18-3	03318033	

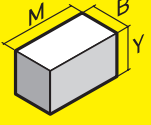
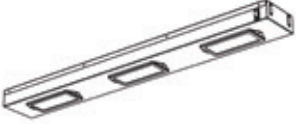
330		Διαστάσεις Dimensions (M x B x Y mm)	ΑΝΟΙΧΤΗ ΠΛΑΤΗ OPEN BACKWALL			ΚΛΕΙΣΤΗ ΠΛΑΤΗ CLOSED BACKWALL					
			Μοντέλο Model	Κωδικός Code	Τιμή € Price €	Μοντέλο Model	Κωδικός Code	Τιμή € Price €			
<b>2-επιπέδων ράφι με κλειστά πλαινά</b> 2-tier overshelf with side closed 			1000	330	350	PEPAD 10-3	03410033		PEPKD 10-3	03510033	
			1100	330	350	PEPAD 11-3	03411033		PEPKD 11-3	03511033	
			1200	330	350	PEPAD 12-3	03412033		PEPKD 12-3	03512033	
			1300	330	350	PEPAD 13-3	03413033		PEPKD 13-3	03513033	
			1400	330	350	PEPAD 14-3	03414033		PEPKD 14-3	03514033	
			1500	330	350	PEPAD 15-3	03415033		PEPKD 15-3	03515033	
			1600	330	350	PEPAD 16-3	03416033		PEPKD 16-3	03516033	
			1700	330	350	PEPAD 17-3	03417033		PEPKD 17-3	03517033	
			1800	330	350	PEPAD 18-3	03418033		PEPKD 18-3	03518033	

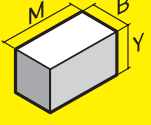
330		ΛΑΜΠΕΣ ΑΛΟΓΟΝΟΥ - HALOGEN LAMPS					
		Λάμπες Lamps	Διαστάσεις Dimensions (M x B x Y mm)	Watt	Μοντέλο Model	Κωδικός Code	Τιμή € Price €
<b>Θερμαντικά στοιχεία</b> Heating unit 		1	280 125 55	1 x 120	FOTAL1 2-1	29901028	
		2	750 125 55	2 x 120	FOTAL2 7-1	29902075	
		3	950 125 55	3 x 120	FOTAL3 9-1	29903095	
		4	1250 125 55	4 x 120	FOTAL4 12-1	29904125	
		5	1450 125 55	5 x 120	FOTAL5 14-1	29905145	
		6	1750 125 55	6 x 120	FOTAL6 17-1	29906175	

330		ΘΕΡΜΑΝΤΙΚΟ ΠΙΑΤΩΝ ΜΕ ΑΝΤΙΣΤΑΣΗ - OHMIC HEATER UNIT					
		Διαστάσεις Dimensions (M x B x Y mm)	Watt	Μοντέλο Model	Κωδικός Code	Τιμή € Price €	
<b>Θερμαντικά στοιχεία</b> Heating unit 		950 152 67	790	FOTANT 9-1	29809515		
		1067 152 67	907	FOTANT 10-1	29810615		
		1292 152 67	1132	FOTANT 12-1	29812915		
		1454 152 67	1294	FOTANT 14-1	29814515		
		1670 152 67	1510	FOTANT 16-1	29816715		
		1812 152 67	1652	FOTANT 18-1	29818115		

# ΡΑΦΙΑ ΤΟΙΧΟΥ ΡΥΘΜΙΖΟΜΕΝΑ

## WALL MOUNTED SHELVES

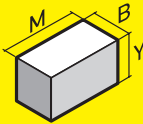
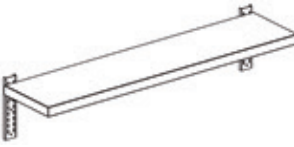
340		Διαστάσεις	Μοντέλο	Κωδικός	Τιμή €
		Dimensions			
		(M x B x Y mm)	Model	Code	Price €
Μονό ράφι τοίχου ρυθμιζόμενο 1-tier shelf with adjustable mechanism		400 340 300	RATRYTM 4-3	03604034	
		600 340 300	RATRYTM 6-3	03606034	
		800 340 300	RATRYTM 8-3	03608034	
		1000 340 300	RATRYTM 10-3	03610034	
		1200 340 300	RATRYTM 12-3	03612034	
		1400 340 300	RATRYTM 14-3	03614034	
		1600 340 300	RATRYTM 16-3	03616034	
		1800 340 300	RATRYTM 18-3	03618034	
		2000 340 300	RATRYTM 20-3	03620034	
		2200 340 300	RATRYTM 22-3	03622034	
		2400 340 300	RATRYTM 24-3	03624034	
		2600 340 300	RATRYTM 26-3	03626034	

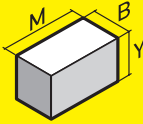
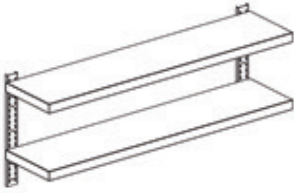
340		Διαστάσεις	Μοντέλο	Κωδικός	Τιμή €
		Dimensions			
		(M x B x Y mm)	Model	Code	Price €
Διπλό ράφι τοίχου ρυθμιζόμενο 2-tier shelf with adjustable mechanism		400 340 550	RATRYTD 4-3	03704034	
		600 340 550	RATRYTD 6-3	03706034	
		800 340 550	RATRYTD 8-3	03708034	
		1000 340 550	RATRYTD 10-3	03710034	
		1200 340 550	RATRYTD 12-3	03712034	
		1400 340 550	RATRYTD 14-3	03714034	
		1600 340 550	RATRYTD 16-3	03716034	
		1800 340 550	RATRYTD 18-3	03718034	
		2000 340 550	RATRYTD 20-3	03720034	
		2200 340 550	RATRYTD 22-3	03722034	
		2400 340 550	RATRYTD 24-3	03724034	
		2600 340 550	RATRYTD 26-3	03726034	

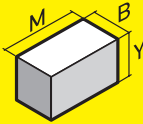
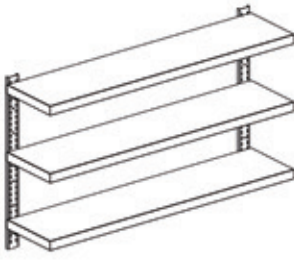
340		Διαστάσεις	Μοντέλο	Κωδικός	Τιμή €
		Dimensions			
		(M x B x Y mm)	Model	Code	Price €
Τριπλό ράφι τοίχου ρυθμιζόμενο 3-tier shelf with adjustable mechanism		400 340 850	RATRYTT 4-3	03804034	
		600 340 850	RATRYTT 6-3	03806034	
		800 340 850	RATRYTT 8-3	03808034	
		1000 340 850	RATRYTT 10-3	03810034	
		1200 340 850	RATRYTT 12-3	03812034	
		1400 340 850	RATRYTT 14-3	03814034	
		1600 340 850	RATRYTT 16-3	03816034	
		1800 340 850	RATRYTT 18-3	03818034	
		2000 340 850	RATRYTT 20-3	03820034	
		2200 340 850	RATRYTT 22-3	03822034	
		2400 340 850	RATRYTT 24-3	03824034	
		2600 340 850	RATRYTT 26-3	03826034	

# ΡΑΦΙΑ ΤΟΙΧΟΥ ΡΥΘΜΙΖΟΜΕΝΑ

## WALL MOUNTED SHELVES

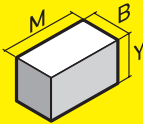
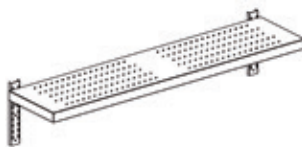

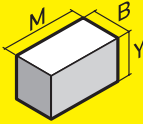
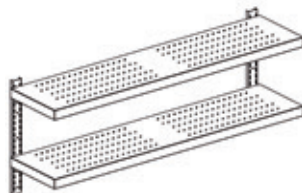
340		Διαστάσεις	Μοντέλο	Κωδικός	Τιμή €
		Dimensions			
		(M x B x Y mm)	Model	Code	Price €
Μονό ράφι τοίχου ρυθμιζόμενο διάτρητο 1-tier shelf perforated with adjustable mechanism		400 340 300	RATRYTMD 4-3	03904034	
		600 340 300	RATRYTMD 6-3	03906034	
		800 340 300	RATRYTMD 8-3	03908034	
		1000 340 300	RATRYTMD 10-3	03910034	
		1200 340 300	RATRYTMD 12-3	03912034	
		1400 340 300	RATRYTMD 14-3	03914034	
		1600 340 300	RATRYTMD 16-3	03916034	
		1800 340 300	RATRYTMD 18-3	03918034	
		2000 340 300	RATRYTMD 20-3	03920034	
		2200 340 300	RATRYTMD 22-3	03922034	
		2400 340 300	RATRYTMD 24-3	03924034	
2600 340 300	RATRYTMD 26-3	03926034			

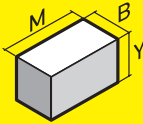
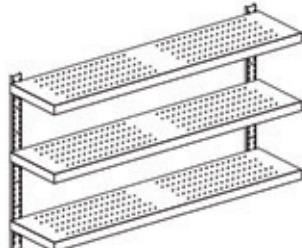

340		Διαστάσεις	Μοντέλο	Κωδικός	Τιμή €
		Dimensions			
		(M x B x Y mm)	Model	Code	Price €
Διπλό ράφι τοίχου ρυθμιζόμενο διάτρητο 2-tier shelf perforated with adjustable mechanism		400 340 550	RATRYTDD 4-3	04004034	
		600 340 550	RATRYTDD 6-3	04006034	
		800 340 550	RATRYTDD 8-3	04008034	
		1000 340 550	RATRYTDD 10-3	04010034	
		1200 340 550	RATRYTDD 12-3	04012034	
		1400 340 550	RATRYTDD 14-3	04014034	
		1600 340 550	RATRYTDD 16-3	04016034	
		1800 340 550	RATRYTDD 18-3	04018034	
		2000 340 550	RATRYTDD 20-3	04020034	
		2200 340 550	RATRYTDD 22-3	04022034	
		2400 340 550	RATRYTDD 24-3	04024034	
2600 340 550	RATRYTDD 26-3	04026034			

340		Διαστάσεις	Μοντέλο	Κωδικός	Τιμή €
		Dimensions			
		(M x B x Y mm)	Model	Code	Price €
Τριπλό ράφι τοίχου ρυθμιζόμενο διάτρητο 3-tier shelf perforated with adjustable mechanism		400 340 850	RATRYTTD 4-3	04104034	
		600 340 850	RATRYTTD 6-3	04106034	
		800 340 850	RATRYTTD 8-3	04108034	
		1000 340 850	RATRYTTD 10-3	04110034	
		1200 340 850	RATRYTTD 12-3	04112034	
		1400 340 850	RATRYTTD 14-3	04114034	
		1600 340 850	RATRYTTD 16-3	04116034	
		1800 340 850	RATRYTTD 18-3	04118034	
		2000 340 850	RATRYTTD 20-3	04120034	
		2200 340 850	RATRYTTD 22-3	04122034	
		2400 340 850	RATRYTTD 24-3	04124034	
2600 340 850	RATRYTTD 26-3	04126034			

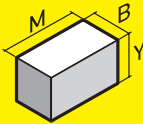

# ΡΑΦΙΑ ΤΟΙΧΟΥ ΣΤΑΘΕΡΑ

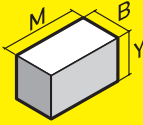
## WALL MOUNTED SHELVES

330		Διαστάσεις	Μοντέλο	Κωδικός	Τιμή €
		Dimensions			
		(M x B x Y mm)	Model	Code	Price €
Μονό ράφι τοίχου σταθερό 1-tier shelf non adjustable		400 330 180	RATSTA 4-3	04204033	
		600 330 180	RATSTA 6-3	04206033	
		800 330 180	RATSTA 8-3	04208033	
		1000 330 180	RATSTA 10-3	04210033	
		1200 330 180	RATSTA 12-3	04212033	
		1400 330 180	RATSTA 14-3	04214033	
		1600 330 180	RATSTA 16-3	04216033	
		1800 330 180	RATSTA 18-3	04218033	
		2000 330 180	RATSTA 20-3	04220033	
		2200 330 180	RATSTA 22-3	04222033	
		2400 330 180	RATSTA 24-3	04224033	
		2600 330 180	RATSTA 26-3	04226033	

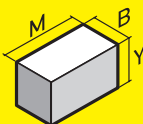
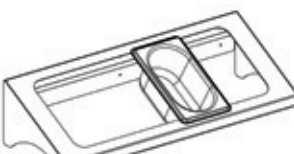

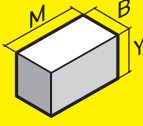
450		Διαστάσεις	Μοντέλο	Κωδικός	Τιμή €
		Dimensions			
		(M x B x Y mm)	Model	Code	Price €
Ράφι σαλαμάνδρας Broiler type shelf		450 450 180	RATSAL 4-4	04304545	
		600 450 180	RATSAL 6-4	04360045	
		800 450 180	RATSAL 8-4	04380045	



175		Διαστάσεις	Μοντέλο	Κωδικός	Τιμή €
		Dimensions			
		(M x B x Y mm)	Model	Code	Price €
Ράφι - θήκη για GN 1/9 Shelf for 1/9 GN storage		500 175 120	RATGN 5-19	04705017	

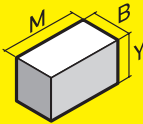

450		Διαστάσεις	Μοντέλο	Κωδικός	Τιμή €
		Dimensions			
		(M x Φ mm)	Model	Code	Price €
Μπάρα για κουτάλες Spoon placement shelf		L500 Φ16	BARK 5-16	04805016	
		L1000 Φ16	BARK 10-16	04810016	
		L1500 Φ16	BARK 15-16	04815016	

# ΡΑΦΙΑ ΤΟΙΧΟΥ ΣΤΑΘΕΡΑ

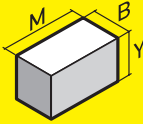
## WALL MOUNTED SHELVES

300		Διαστάσεις	Μοντέλο	Κωδικός	Τιμή €
		Dimensions			
		(M x B x Y mm)	Model	Code	Price €
Ράφι τοίχου σωληνωτό Round tube type		800 300 180	RATSOL 8-3	04408030	
		1000 300 180	RATSOL 10-3	04410030	
		1200 300 180	RATSOL 12-3	04412030	
		1400 300 180	RATSOL 14-3	04414030	
		1600 300 180	RATSOL 16-3	04416030	
		1800 300 180	RATSOL 18-3	04418030	

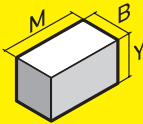
400		Διαστάσεις	Μοντέλο	Κωδικός	Τιμή €
		Dimensions			
		(M x B x Y mm)	Model	Code	Price €
Ράφι τοίχου σωληνωτό Round tube type		800 400 180	RATSOL 8-4	04508040	
		1000 400 180	RATSOL 10-4	04510040	
		1200 400 180	RATSOL 12-4	04512040	
		1400 400 180	RATSOL 14-4	04514040	
		1600 400 180	RATSOL 16-4	04516040	
		1800 400 180	RATSOL 18-4	04518040	

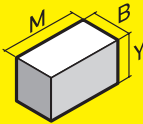
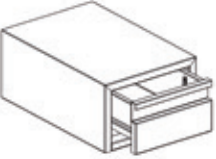

300		Διαστάσεις	Μοντέλο	Κωδικός	Τιμή €
		Dimensions			
		(M x B x Y mm)	Model	Code	Price €
Ράφι τοίχου σωληνωτό φούσκας Round tube type Range hood mounted		800 300 300	RATFSK 8-3	04608030	
		1000 300 300	RATFSK 10-3	04610030	
		1200 300 300	RATFSK 12-3	04612030	
		1400 300 300	RATFSK 14-3	04614030	
		1600 300 300	RATFSK 16-3	04616030	
		1800 300 300	RATFSK 18-3	04618030	

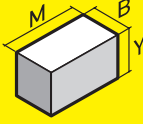
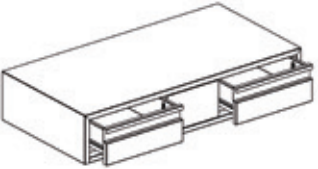

<b>500</b>		<b>Διαστάσεις Dimensions</b>  (M x B x Y mm)	<b>Μοντέλο Model</b>	<b>Κωδικός Code</b>	<b>Τιμή € Price €</b>		
<b>Μονό συρτάρι καφέ</b> 1-tier coffee drawer unit  		400 500 180	CST1SRT 4-5	31404050			

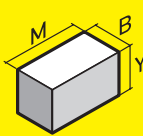

<b>500</b>		<b>Διαστάσεις Dimensions</b>  (M x B x Y mm)	<b>Μοντέλο Model</b>	<b>Κωδικός Code</b>	<b>Τιμή € Price €</b>		
<b>Διπλό συρτάρι καφέ</b> 2-tier coffee drawer unit  		800 500 180	CST2SRT 8-5	31508050			
		1000 500 180	CST2SRT 10-5	31510050			

# ΕΡΜΑΡΙΑ ΚΑΦΕ

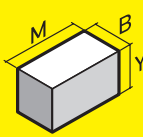
## COFFEE STATION CUPBOARDS

600		<b>Διαστάσεις</b> <b>Dimensions</b> (M x B x Y mm)	ΧΩΡΙΣ ΠΑΝΩΣΗΚΩΜΑ WITHOUT UPSTAND			ΜΕ ΠΑΝΩΣΗΚΩΜΑ WITH UPSTAND		
			Μοντέλο Model	Κωδικός Code	Τιμή € Price €	Μοντέλο Model	Κωδικός Code	Τιμή € Price €
<b>Με 2 ανοιγόμενες πόρτες &amp; 2 συρτάρια</b> With 2 hinged doors & 2 drawer units		850 600 860	CST2S2P 8-6	30008560		CST2S2PP 8-6	30108560	
		900 600 860	CST2S2P 9-6	30009060		CST2S2PP 9-6	30109060	
		1000 600 860	CST2S2P 10-6	30010060		CST2S2PP 10-6	30110060	
		1100 600 860	CST2S2P 11-6	30011060		CST2S2PP 11-6	30111060	

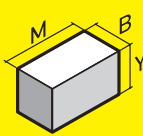
600		<b>Διαστάσεις</b> <b>Dimensions</b> (M x B x Y mm)	ΧΩΡΙΣ ΠΑΝΩΣΗΚΩΜΑ WITHOUT UPSTAND			ΜΕ ΠΑΝΩΣΗΚΩΜΑ WITH UPSTAND		
			Μοντέλο Model	Κωδικός Code	Τιμή € Price €	Μοντέλο Model	Κωδικός Code	Τιμή € Price €
<b>Με 1 ανοιγόμενη πόρτα, 1 αμπάρι &amp; 2 συρτάρια</b> With 1 hinged door, 1 hopper & 2 drawer units		850 600 860	CST2S1P1A 8-6	30208560		CST2S1P1AP 8-6	30308560	
		900 600 860	CST2S1P1A 9-6	30209060		CST2S1P1AP 9-6	30309060	
		1000 600 860	CST2S1P1A 10-6	30210060		CST2S1P1AP 10-6	30310060	
		1100 600 860	CST2S1P1A 11-6	30211060		CST2S1P1AP 11-6	30311060	

600		<b>Διαστάσεις</b> <b>Dimensions</b> (M x B x Y mm)	ΧΩΡΙΣ ΠΑΝΩΣΗΚΩΜΑ WITHOUT UPSTAND			ΜΕ ΠΑΝΩΣΗΚΩΜΑ WITH UPSTAND		
			Μοντέλο Model	Κωδικός Code	Τιμή € Price €	Μοντέλο Model	Κωδικός Code	Τιμή € Price €
<b>Με συρόμενες πόρτες, 2 συρτάρια &amp; 1 αμπάρι</b> With sliding door, 2 drawer units & 1 hopper		1470 600 860	CSTSM2S1A 14-6	30814760		CSTSM2S1AP 14-6	30914760	

# ΕΡΜΑΡΙΑ ΚΑΦΕ

## COFFEE STATION CUPBOARDS

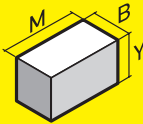
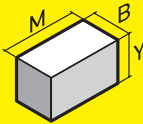
600		<b>Διαστάσεις</b> <b>Dimensions</b> (M x B x Y mm)	ΧΩΡΙΣ ΠΑΝΩΣΗΚΩΜΑ WITHOUT UPSTAND			ΜΕ ΠΑΝΩΣΗΚΩΜΑ WITH UPSTAND		
			Μοντέλο Model	Κωδικός Code	Τιμή € Price €	Μοντέλο Model	Κωδικός Code	Τιμή € Price €
Με 2 πόρτες, 2 συρτάρια, 1 αμπάρι & ρίνσερ		2000 600 860	CST2S2P1AR 20-6	30420060		CST2S2P1ARP 20-6	30520060	

With 2 doors,  
2 drawer units,  
1 hopper  
& rinser

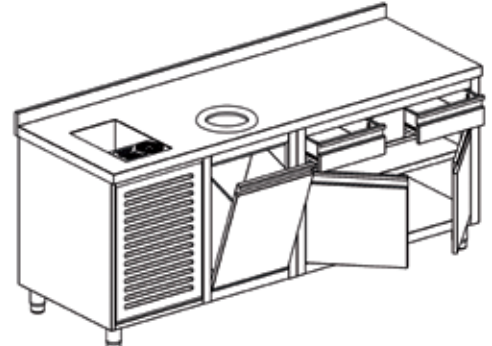
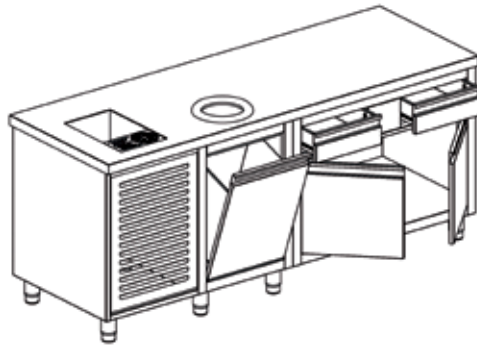
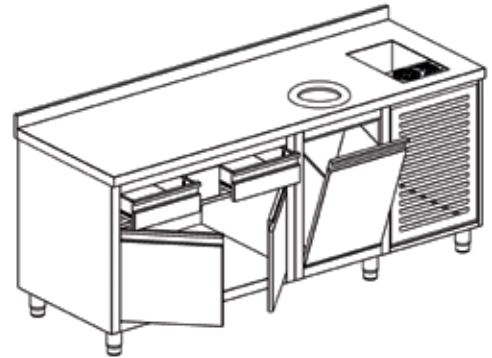
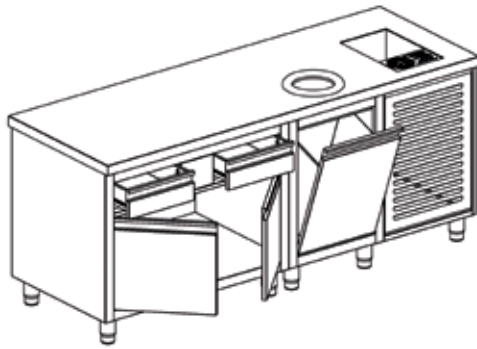

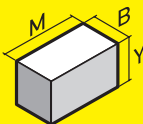
600		<b>Διαστάσεις</b> <b>Dimensions</b> (M x B x Y mm)	ΧΩΡΙΣ ΠΑΝΩΣΗΚΩΜΑ WITHOUT UPSTAND			ΜΕ ΠΑΝΩΣΗΚΩΜΑ WITH UPSTAND		
			Μοντέλο Model	Κωδικός Code	Τιμή € Price €	Μοντέλο Model	Κωδικός Code	Τιμή € Price €
Με 2 πόρτες, 2 συρτάρια, 1 αμπάρι, ρίνσερ & θέση μονάδας		2350 600 900	CST2S2P1ARG 20-6	30623560		CST2S2P1ARGP 20-6	30723560	

With 2 doors,  
2 drawer units,  
1 hopper, rinser  
& build in unit

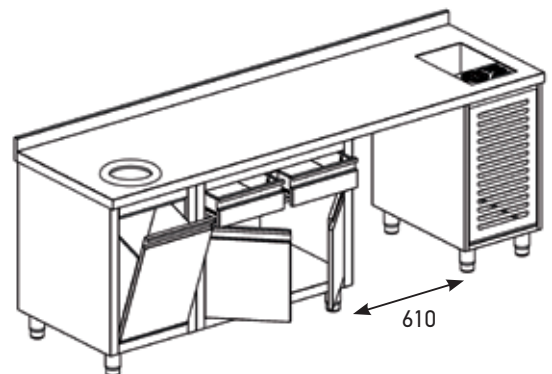
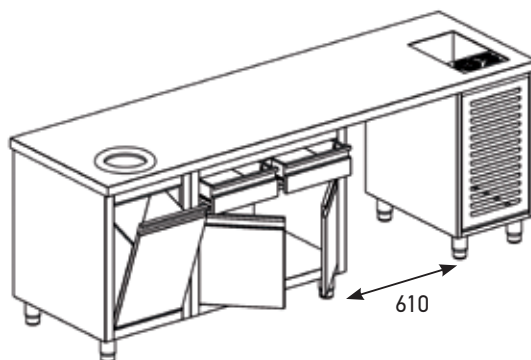

# ΕΡΜΑΡΙΑ ΚΑΦΕ

## COFFEE STATION CUPBOARDS

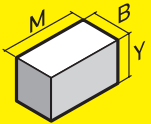
600		Διαστάσεις Dimensions (M x B x Y mm)	ΧΩΡΙΣ ΠΑΝΩΣΗΚΩΜΑ WITHOUT UPSTAND			ΜΕ ΠΑΝΩΣΗΚΩΜΑ WITH UPSTAND		
			Μοντέλο Model	Κωδικός Code	Τιμή € Price €	Μοντέλο Model	Κωδικός Code	Τιμή € Price €
Με 2 πόρτες, 2 συρτάρια, 1 αμπάρι, ρίνσερ, & κενό για ψυγείο 60x52x87 εκ.		2300 600 900	CSTFR60S2 23-6	31023060		CSTFR60S2P 23-6	31123060	

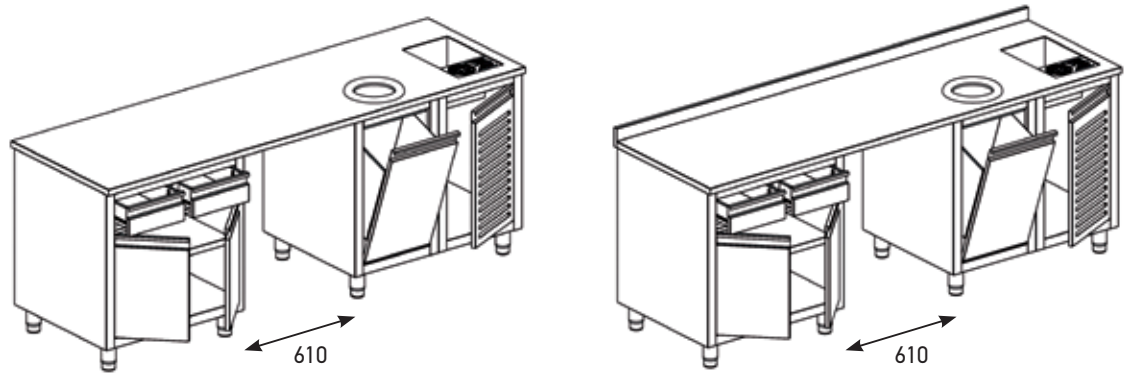

With 2 doors,  
2 drawer units,  
1 hopper, rinser  
& built in unit  
back bar  
60x52x87 cm

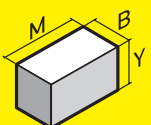

600		Διαστάσεις Dimensions (M x B x Y mm)	ΧΩΡΙΣ ΠΑΝΩΣΗΚΩΜΑ WITHOUT UPSTAND			ΜΕ ΠΑΝΩΣΗΚΩΜΑ WITH UPSTAND		
			Μοντέλο Model	Κωδικός Code	Τιμή € Price €	Μοντέλο Model	Κωδικός Code	Τιμή € Price €
Με 1 πόρτα, 1 συρτάρι, 1 αμπάρι, ρίνσερ, & κενό για ψυγείο 90x52x87 εκ.		2300 600 900	CSTFR90S2 23-6	31223060		CSTFR90S2P 23-6	31323060	

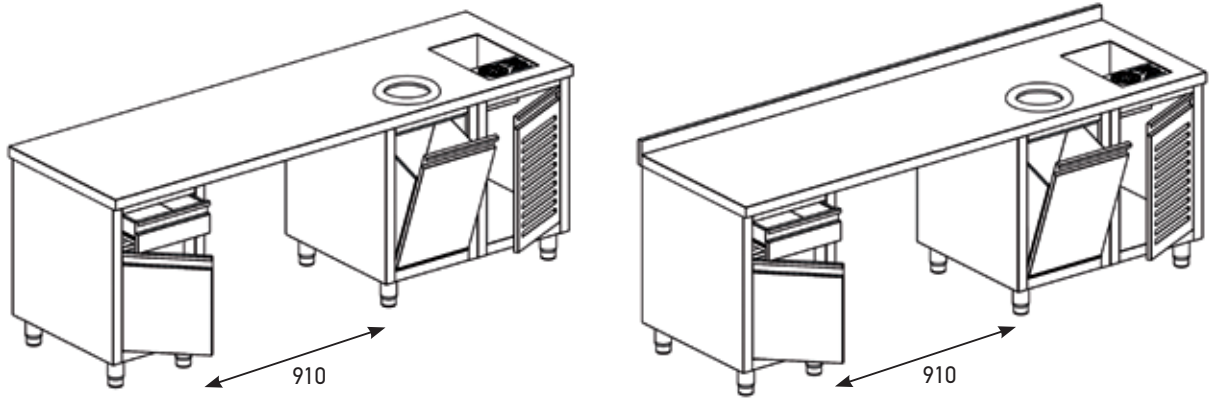
With 1 door,  
1 drawer unit,  
1 hopper, rinser  
& built in unit  
back bar  
90x52x87 cm

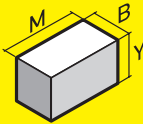



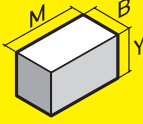
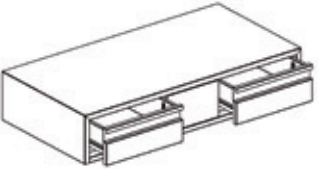

500		Διαστάσεις	Μοντέλο	Κωδικός	Τιμή €	
		Dimensions				Model
		(M x B x Y mm)				
<b>Μονό συρτάρι καφέ</b> 1-tier coffee drawer unit  		400 500 180	CST1SRT 4-5	31404050		

500		Διαστάσεις	Μοντέλο	Κωδικός	Τιμή €	
		Dimensions				Model
		(M x B x Y mm)				
<b>Διπλό συρτάρι καφέ</b> 2-tier coffee drawer unit  		800 500 180	CST2SRT 8-5	31508050		
		1000 500 180	CST2SRT 10-5	31510050		

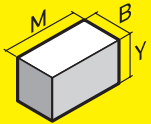
# ΕΡΜΑΡΙΑ ΚΑΦΕ

## COFFEE STATION CUPBOARDS

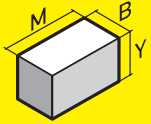
700		<b>Διαστάσεις</b> <b>Dimensions</b> (M x B x Y mm)	ΧΩΡΙΣ ΠΑΝΩΣΗΚΩΜΑ WITHOUT UPSTAND			ΜΕ ΠΑΝΩΣΗΚΩΜΑ WITH UPSTAND		
			Μοντέλο Model	Κωδικός Code	Τιμή € Price €	Μοντέλο Model	Κωδικός Code	Τιμή € Price €
<b>Με 2 ανοιγόμενες πόρτες &amp; 2 συρτάρια</b> With 2 hinged doors & 2 drawer units		850 700 860	CST2S2P 8-7	30008570		CST2S2PP 8-7	30108570	
		900 700 860	CST2S2P 9-7	30009070		CST2S2PP 9-7	30109070	
		1000 700 860	CST2S2P 10-7	30010070		CST2S2PP 10-7	30110070	
		1100 700 860	CST2S2P 11-7	30011070		CST2S2PP 11-7	30111070	

700		<b>Διαστάσεις</b> <b>Dimensions</b> (M x B x Y mm)	ΧΩΡΙΣ ΠΑΝΩΣΗΚΩΜΑ WITHOUT UPSTAND			ΜΕ ΠΑΝΩΣΗΚΩΜΑ WITH UPSTAND		
			Μοντέλο Model	Κωδικός Code	Τιμή € Price €	Μοντέλο Model	Κωδικός Code	Τιμή € Price €
<b>Με 1 ανοιγόμενη πόρτα, 1 αμπάρι &amp; 2 συρτάρια</b> With 1 hinged door, 1 hopper & 2 drawer units		850 700 860	CST2S1P1A 8-7	30208570		CST2S1P1AP 8-7	30308570	
		900 700 860	CST2S1P1A 9-7	30209070		CST2S1P1AP 9-7	30309070	
		1000 700 860	CST2S1P1A 10-7	30210070		CST2S1P1AP 10-7	30310070	
		1100 700 860	CST2S1P1A 11-7	30211070		CST2S1P1AP 11-7	30311070	

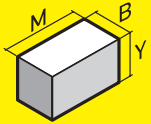
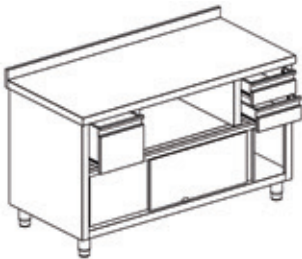
700		<b>Διαστάσεις</b> <b>Dimensions</b> (M x B x Y mm)	ΧΩΡΙΣ ΠΑΝΩΣΗΚΩΜΑ WITHOUT UPSTAND			ΜΕ ΠΑΝΩΣΗΚΩΜΑ WITH UPSTAND		
			Μοντέλο Model	Κωδικός Code	Τιμή € Price €	Μοντέλο Model	Κωδικός Code	Τιμή € Price €
<b>Με συρόμενες πόρτες, 2 συρτάρια &amp; 1 αμπάρι</b> With sliding door, 2 drawer units & 1 hopper		1470 700 860	CSTSM2S1A 14-7	30814770		CSTSM2S1AP 14-7	30914770	

# ΕΡΜΑΡΙΑ ΚΑΦΕ

## COFFEE STATION CUPBOARDS

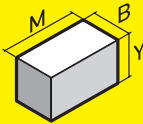
700		<b>Διαστάσεις</b> <b>Dimensions</b> (M x B x Y mm)	ΧΩΡΙΣ ΠΑΝΩΣΗΚΩΜΑ WITHOUT UPSTAND			ΜΕ ΠΑΝΩΣΗΚΩΜΑ WITH UPSTAND		
			Μοντέλο Model	Κωδικός Code	Τιμή € Price €	Μοντέλο Model	Κωδικός Code	Τιμή € Price €
Με 2 πόρτες, 2 συρτάρια, 1 αμπάρι & ρίνσερ		2000 700 860	CST2S2P1AR 20-7	30420070		CST2S2P1ARP 20-7	30520070	

With 2 doors,  
2 drawer units,  
1 hopper  
& rinser

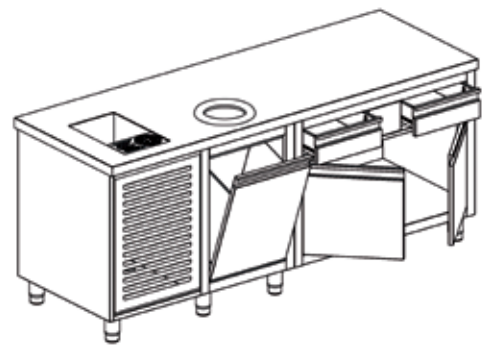
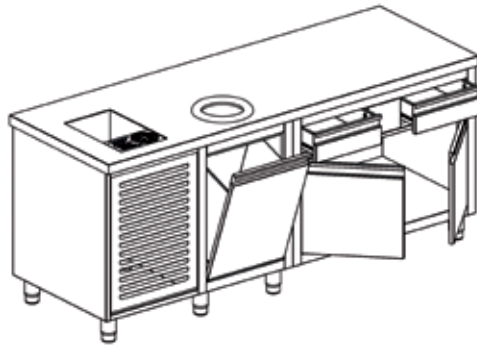
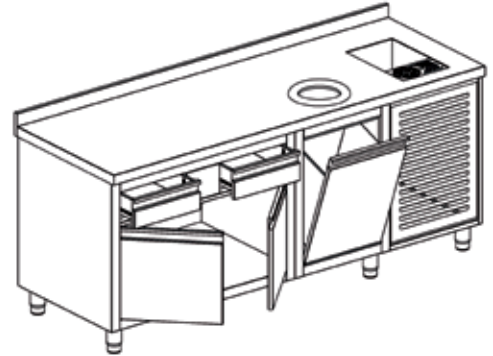
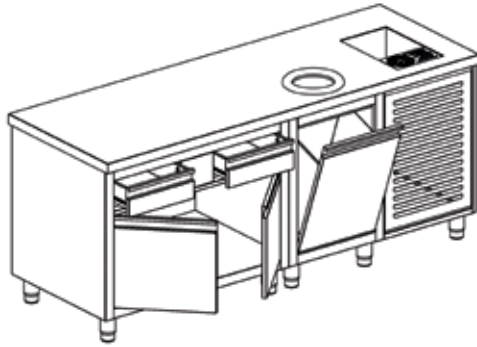

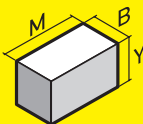
700		<b>Διαστάσεις</b> <b>Dimensions</b> (M x B x Y mm)	ΧΩΡΙΣ ΠΑΝΩΣΗΚΩΜΑ WITHOUT UPSTAND			ΜΕ ΠΑΝΩΣΗΚΩΜΑ WITH UPSTAND		
			Μοντέλο Model	Κωδικός Code	Τιμή € Price €	Μοντέλο Model	Κωδικός Code	Τιμή € Price €
Με 2 πόρτες, 2 συρτάρια, 1 αμπάρι, ρίνσερ & θέση μονάδας		2350 700 900	CST2S2P1ARG 23-7	30623570		CST2S2P1ARGP 23-7	30723570	

With 2 doors,  
2 drawer units,  
1 hopper, rinser  
& build in unit

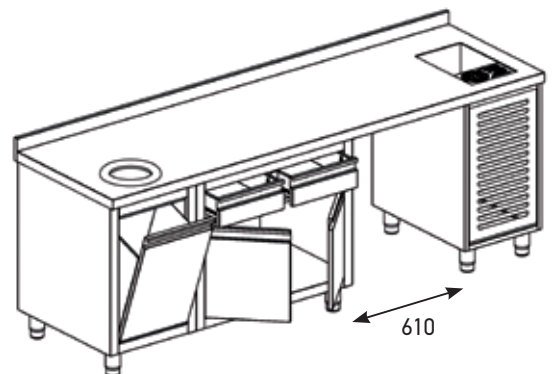
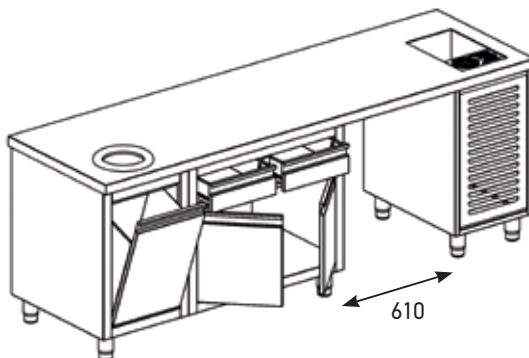

# ΕΡΜΑΡΙΑ ΚΑΦΕ

## COFFEE STATION CUPBOARDS

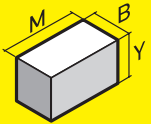
700		<b>Διαστάσεις</b> <b>Dimensions</b> (M x B x Y mm)	ΧΩΡΙΣ ΠΑΝΩΣΗΚΩΜΑ WITHOUT UPSTAND			ΜΕ ΠΑΝΩΣΗΚΩΜΑ WITH UPSTAND		
			Μοντέλο Model	Κωδικός Code	Τιμή € Price €	Μοντέλο Model	Κωδικός Code	Τιμή € Price €
Με 2 πόρτα, 2 συρτάρια, 1 αμπάρι, ρίνσερ, & κενό για ψυγείο 60x52x87 εκ.		2300 700 900	CSTFR60S2 23-7	31023070		CSTFR60S2P 23-7	31123070	

With 2 doors,  
2 drawer units,  
1 hopper, rinser  
& built in unit  
back bar  
60x52x87 cm

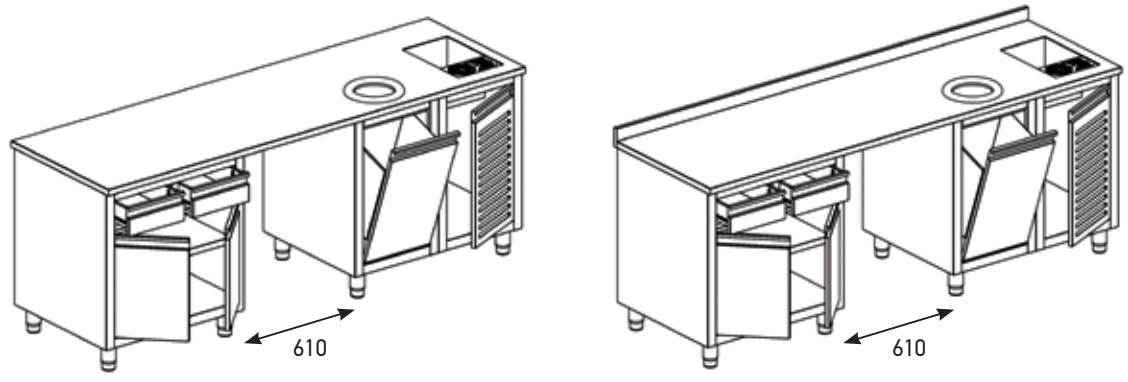

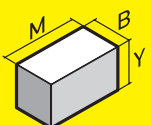
700		<b>Διαστάσεις</b> <b>Dimensions</b> (M x B x Y mm)	ΧΩΡΙΣ ΠΑΝΩΣΗΚΩΜΑ WITHOUT UPSTAND			ΜΕ ΠΑΝΩΣΗΚΩΜΑ WITH UPSTAND		
			Μοντέλο Model	Κωδικός Code	Τιμή € Price €	Μοντέλο Model	Κωδικός Code	Τιμή € Price €
Με 1 πόρτα, 1 συρτάρι, 1 αμπάρι, ρίνσερ, & κενό για ψυγείο 90x52x87 εκ.		2300 700 900	CSTFR90S2 23-7	31223070		CSTFR90S2P 23-7	31323070	

With 1 door,  
1 drawer unit,  
1 hopper, rinser  
& built in unit  
back bar  
90x52x87 cm

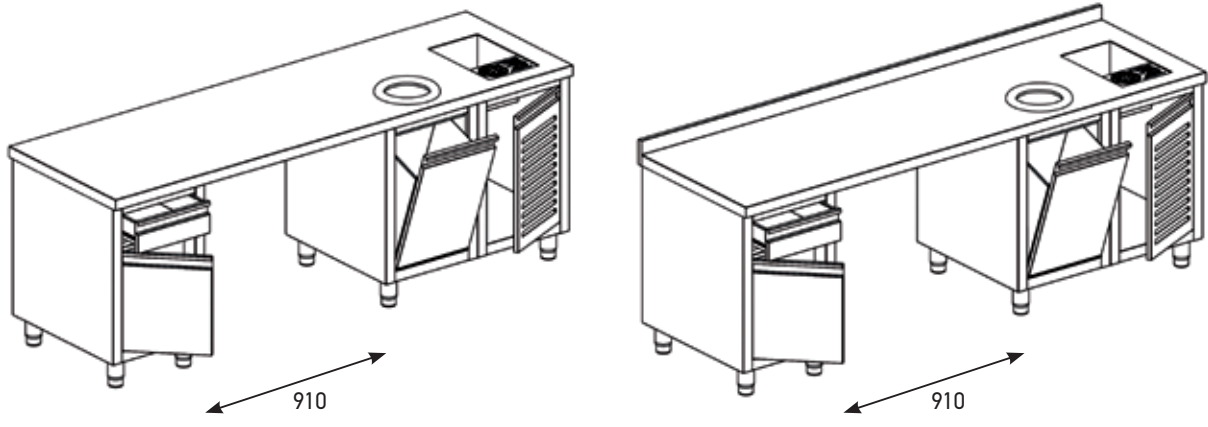

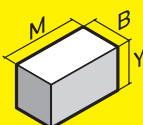
545		Διαστάσεις	Μοντέλο	Κωδικός	Τιμή €
		Dimensions			
		(M x B x Y mm)			
Αποθήκη πάγου & μπουκαλιέρα Ice & bottle storage		700	BST0P0B 7-5	32007054	
		800	BST0P0B 8-5	32008054	
		1000	BST0P0B 10-5	32010054	

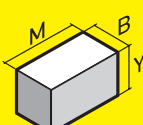

545		Διαστάσεις	Μοντέλο	Κωδικός	Τιμή €
		Dimensions			
		(M x B x Y mm)			
Αποθήκη πάγου, μπουκαλιέρα & γούρνα με χωνευτό ρίνσερ Ice, bottle storage, sink & counter top rinser		1000	BST0PGB 10-5	32110054	
		1200	BST0PGB 12-5	32112054	
		1400	BST0PGB 14-5	32114054	
		1600	BST0PGB 16-5	32116054	
		2000	BST0PGB 20-5	32120054	

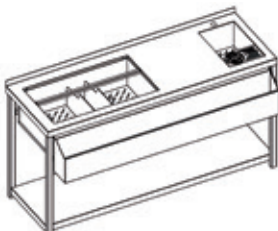

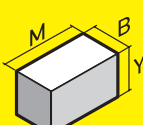
545		Διαστάσεις	Μοντέλο	Κωδικός	Τιμή €
		Dimensions			
		(M x B x Y mm)			
Αποθήκη πάγου, μπουκαλιέρα, γούρνα με χωνευτό ρίνσερ & κάδος Ice, bottle storage, sink counter top rinser & waste can		1200	BST0PGBK 12-5	32212054	
		1400	BST0PGBK 14-5	32214054	
		1600	BST0PGBK 16-5	32216054	

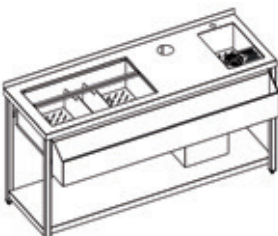

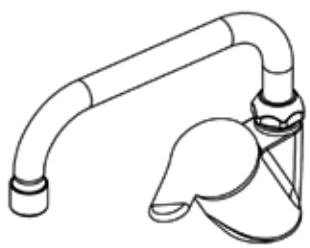
Βρύση Tap	
	
Διαστάσεις - Dimensions	
Μοντέλο - Model	VRS-CLAS
Κωδικός - Code	82000000
Τιμή € - Price €	

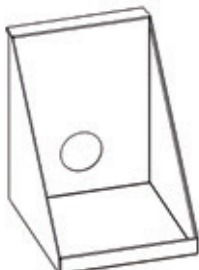
Βάση Μπλέντερ Blender	
	
Διαστάσεις - Dimensions	200 235 260
Μοντέλο - Model	BLND
Κωδικός - Code	33020026
Τιμή € - Price €	

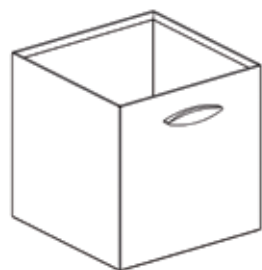
Κάδος απορριμάτων Αποθήκευσης μπουκαλιών Waste can / Bottle storage	
	
Διαστάσεις - Dimensions	300 300 300
Μοντέλο - Model	KAD 3-3
Κωδικός - Code	33130030
Τιμή € - Price €	

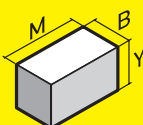
<p><b>545</b></p> 	<p><b>Διαστάσεις</b> <b>Dimensions</b></p> <p>(M x B x Y mm)</p>	<p><b>Μοντέλο</b> <b>Model</b></p>	<p><b>Θέσεις</b> <b>Capability</b></p>	<p><b>Κωδικός</b> <b>Code</b></p>	<p><b>Τιμή €</b> <b>Price €</b></p>
	<p>2000 545 860</p>	<p><b>BSTGPGB 20-5</b></p>	<p>11x1/9 GN</p>	<p>32320054</p>	

- Αποθήκη πάγου & μπουκαλιέρα
- 2 γούρνες με κωνευτό ρίνσερ
- Κάδος τροχήλατος
- Θέσεις για 1/9 GN

- Ice & bottle storage
- 2 sinks & counter top rinser
- Waste can on wheels
- 1/9 Gastro-norm capability

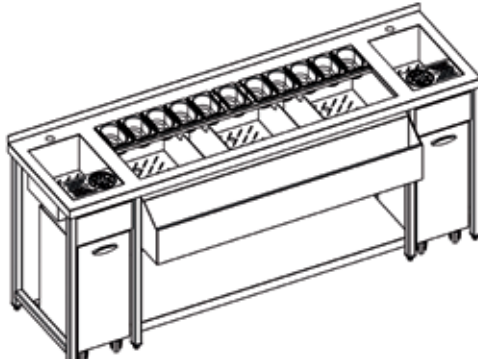

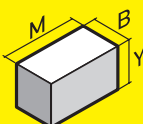
<p><b>545</b></p> 	<p><b>Διαστάσεις</b> <b>Dimensions</b></p> <p>(M x B x Y mm)</p>	<p><b>Μοντέλο</b> <b>Model</b></p>	<p><b>Κωδικός</b> <b>Code</b></p>	<p><b>Τιμή €</b> <b>Price €</b></p>
	<p>2400 545 860</p>	<p><b>BSTGPG 24-5</b></p>	<p>32424054</p>	

- 2 αποθήκες πάγου & 2 μπουκαλιέρες
- 1 διπλή γούρνα με διπλό κωνευτό ρίνσερ
- Θέση για κάδους

- 2 Ice & bottle storage
- 1 double sink with double counter top rinser
- Waste & bottle can capability

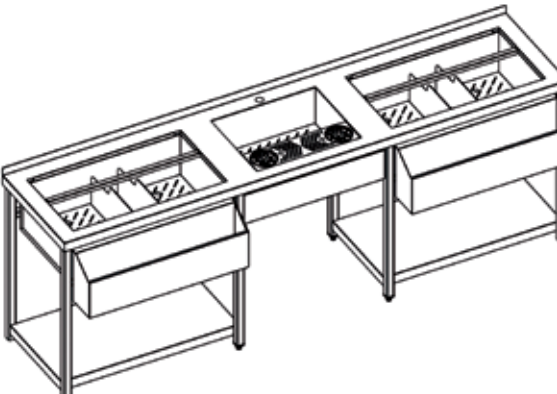

**Βρύση**  
**Tap**



<b>Διαστάσεις - Dimensions</b>	
<b>Μοντέλο - Model</b>	<b>VRS-CLAS</b>
<b>Κωδικός - Code</b>	82000000
<b>Τιμή € - Price €</b>	

**Βάση Μπλέντερ**  
**Blender**

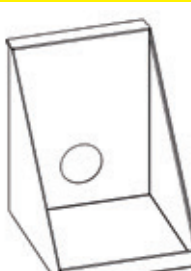

<b>Διαστάσεις - Dimensions</b>	200 235 260
<b>Μοντέλο - Model</b>	<b>BLND</b>
<b>Κωδικός - Code</b>	33020026
<b>Τιμή € - Price €</b>	

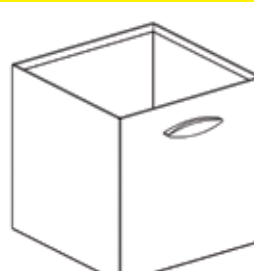

**Κάδος απορριμάτων**  
**Αποθήκευση μπουκαλιών**  
**Waste can / Bottle storage**

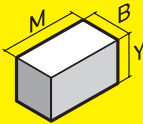
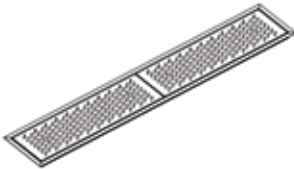

<b>Διαστάσεις - Dimensions</b>	300 300 300
<b>Μοντέλο - Model</b>	<b>KAD 3-3</b>
<b>Κωδικός - Code</b>	33130030
<b>Τιμή € - Price €</b>	

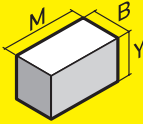
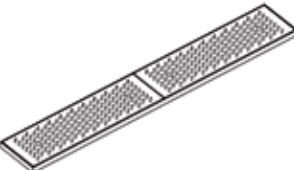
120		Διαστάσεις	Μοντέλο	Κωδικός	Τιμή €
		Dimensions			
		(M x B x Y mm)	Model	Code	Price €
Μπαρ ματ με εξωτερικά γυρίσματα Bar matte build-in		500 120 22	BMT1EXO 5-1	35050015	
		996 120 22	BMT2EXO 9-1	35099615	
		1492 120 22	BMT3EXO 14-1	35014915	
		1988 120 22	BMT4EXO 19-1	35019815	

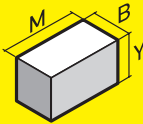
120		Διαστάσεις	Μοντέλο	Κωδικός	Τιμή €
		Dimensions			
		(M x B x Y mm)	Model	Code	Price €
Μπαρ ματ με εσωτερικά γυρίσματα Bar matte on table		500 120 22	BMT1MESA 5-1	35150015	
		996 120 22	BMT2MESA 9-1	35199615	
		1492 120 22	BMT3MESA 14-1	35114915	
		1988 120 22	BMT4MESA 19-1	35119815	

140		Διαστάσεις	Μοντέλο	Κωδικός	Τιμή €
		Dimensions			
		(M x B x Y mm)	Model	Code	Price €
Χωνευτό ρίνσερ Counter top glass rinser build-in		300 140 26	RINEXO 3-1	35230014	

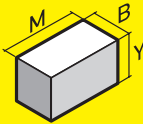
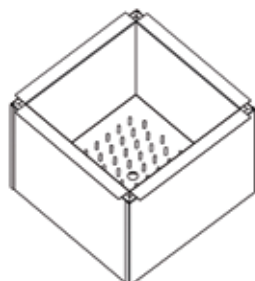
330 380		Διαστάσεις Dimensions (M x B x Y mm)	ΜΕ ΔΙΑΒΑΘΜΙΣΗ - PIVOT			
			Μοντέλο Model	Κωδικός Code	Τιμή € Price €	
<p>Αποθήκη πάγου για συγκόλληση, με θυρίδες plexi glass Built-in ice storage, with plexi glass openings</p> 		330 330 275	PAGP 3-3	35433030		
		380 380 300	PAGP 3-4	35438045		

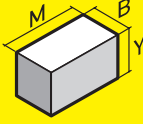
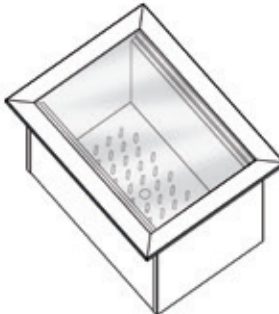
350 430		Διαστάσεις Dimensions (M x B x Y mm)	ΧΩΡΙΣ ΔΙΑΒΑΘΜΙΣΗ BASIC			ΜΕ ΔΙΑΒΑΘΜΙΣΗ PIVOT			
			Μοντέλο Model	Κωδικός Code	Τιμή € Price €	Μοντέλο Model	Κωδικός Code	Τιμή € Price €	
<p>Αποθήκη πάγου ένθετη, με θυρίδες plexi glass Removable ice storage, with plexi glass openings</p> 		250 350 250	PAGR 2-3	35525035		PAGRP 2-3	35625035		
		330 430 300	PAGR 3-4	35533043		PAGRP 3-4	35633043		
		380 380 300	PAGR 3-3	35538038		PAGRP 3-3	35638038		

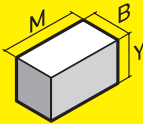
600		Διαστάσεις	Γούρνα	Μοντέλο	Κωδικός	Τιμή €
		Dimensions	Sink	Model	Code	Price €
		(M x B x Y mm)	(M x B mm)			
<b>Χωρίς ράφι - Without lower shelf</b>						
		600 600 860	400 x 400	LNG1C 6-64	10006064	
		700 600 860	400 x 400	LNG1C 7-64	10007064	
		800 600 860	400 x 400	LNG1C 8-64	10008064	
		900 600 860	400 x 400	LNG1C 9-64	10009064	
<b>Με ράφι - With lower shelf</b>						
		600 600 860	400 x 400	LNG1CS 6-64	10106064	
		700 600 860	400 x 400	LNG1CS 7-64	10107064	
		800 600 860	400 x 400	LNG1CS 8-64	10108064	
		900 600 860	400 x 400	LNG1CS 9-64	10109064	

Ανοιχτή,  
με 1 γούρνα στο κέντρο  
1 sink centered,  
open sides on legs



Ανοιχτή,  
με 1 γούρνα αριστερά  
1 sink on left,  
open sides on legs



<b>Χωρίς ράφι - Without lower shelf</b>						
1000	600	860	400 x 400	LNG1L 10-64	10210064	
1100	600	860	400 x 400	LNG1L 11-64	10211064	
1200	600	860	400 x 400	LNG1L 12-64	10212064	
1300	600	860	400 x 400	LNG1L 13-64	10213064	
1400	600	860	400 x 400	LNG1L 14-64	10214064	
<b>Με ράφι - With lower shelf</b>						
1000	600	860	400 x 400	LNG1LS 10-64	10310064	
1100	600	860	400 x 400	LNG1LS 11-64	10311064	
1200	600	860	400 x 400	LNG1LS 12-64	10312064	
1300	600	860	400 x 400	LNG1LS 13-64	10313064	
1400	600	860	400 x 400	LNG1LS 14-64	10314064	

Ανοιχτή,  
με 1 γούρνα δεξιά  
1 sink on right,  
open sides on legs

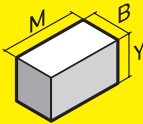

<b>Χωρίς ράφι - Without lower shelf</b>						
1000	600	860	400 x 400	LNG1R 10-64	10410064	
1100	600	860	400 x 400	LNG1R 11-64	10411064	
1200	600	860	400 x 400	LNG1R 12-64	10412064	
1300	600	860	400 x 400	LNG1R 13-64	10413064	
1400	600	860	400 x 400	LNG1R 14-64	10414064	
<b>Με ράφι - With lower shelf</b>						
1000	600	860	400 x 400	LNG1RS 10-64	10510064	
1100	600	860	400 x 400	LNG1RS 11-64	10511064	
1200	600	860	400 x 400	LNG1RS 12-64	10512064	
1300	600	860	400 x 400	LNG1RS 13-64	10513064	
1400	600	860	400 x 400	LNG1RS 14-64	10514064	

600		Διαστάσεις	Γούρνα	Μοντέλο	Κωδικός	Τιμή €
		Dimensions	Sink	Model	Code	Price €
		(M x B x Y mm)	(M x B mm)			
<b>Χωρίς ράφι - Without lower shelf</b>						
		1000 600 860	400 x 400	LNG2C 10-64	10610064	
		1100 600 860	400 x 400	LNG2C 11-64	10611064	
		1200 600 860	400 x 400	LNG2C 12-64	10612064	
		1500 600 860	400 x 400	LNG2C 15-64	10615064	
		1600 600 860	400 x 400	LNG2C 16-64	10616064	
<b>Με ράφι - With lower shelf</b>						
		1000 600 860	400 x 400	LNG2CS 10-64	10710064	
		1100 600 860	400 x 400	LNG2CS 11-64	10711064	
		1200 600 860	400 x 400	LNG2CS 12-64	10712064	
		1500 600 860	400 x 400	LNG2CS 15-64	10715064	
		1600 600 860	400 x 400	LNG2CS 16-64	10716064	

Ανοιχτή,  
με 2 γούρνες στο κέντρο  
2 sinks centered,  
open sides on legs



Ανοιχτή,  
με 2 γούρνες αριστερά  
2 sinks on left,  
open sides on legs

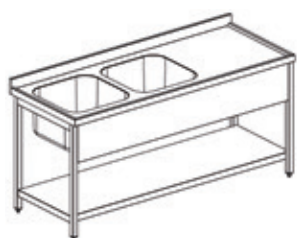

<b>Χωρίς ράφι - Without lower shelf</b>						
		1400 600 860	400 x 400	LNG2L 14-64	10814064	
		1500 600 860	400 x 400	LNG2L 15-64	10815064	
		1600 600 860	400 x 400	LNG2L 16-64	10816064	
		1700 600 860	400 x 400	LNG2L 17-64	10817064	
		1800 600 860	400 x 400	LNG2L 18-64	10818064	
		1900 600 860	400 x 400	LNG2L 19-64	10819064	
		2000 600 860	400 x 400	LNG2L 20-64	10820064	
<b>Με ράφι - With lower shelf</b>						
		1400 600 860	400 x 400	LNG2LS 14-64	10914064	
		1500 600 860	400 x 400	LNG2LS 15-64	10915064	
		1600 600 860	400 x 400	LNG2LS 16-64	10916064	
		1700 600 860	400 x 400	LNG2LS 17-64	10917064	
		1800 600 860	400 x 400	LNG2LS 18-64	10918064	
		1900 600 860	400 x 400	LNG2LS 19-64	10919064	
		2000 600 860	400 x 400	LNG2LS 20-64	10920064	

Ανοιχτή,  
με 2 γούρνες δεξιά  
2 sinks on right,  
open sides on legs

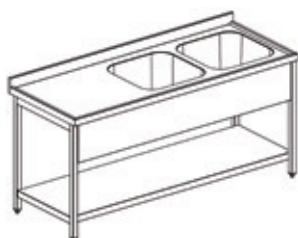

<b>Χωρίς ράφι - Without lower shelf</b>						
		1400 600 860	400 x 400	LNG2R 14-64	11014064	
		1500 600 860	400 x 400	LNG2R 15-64	11015064	
		1600 600 860	400 x 400	LNG2R 16-64	11016064	
		1700 600 860	400 x 400	LNG2R 17-64	11017064	
		1800 600 860	400 x 400	LNG2R 18-64	11018064	
		1900 600 860	400 x 400	LNG2R 19-64	11019064	
		2000 600 860	400 x 400	LNG2R 20-64	11020064	
<b>Με ράφι - With lower shelf</b>						
		1400 600 860	400 x 400	LNG2RS 14-64	11114064	
		1500 600 860	400 x 400	LNG2RS 15-64	11115064	
		1600 600 860	400 x 400	LNG2RS 16-64	11116064	
		1700 600 860	400 x 400	LNG2RS 17-64	11117064	
		1800 600 860	400 x 400	LNG2RS 18-64	11118064	
		1900 600 860	400 x 400	LNG2RS 19-64	11119064	
		2000 600 860	400 x 400	LNG2RS 20-64	11120064	

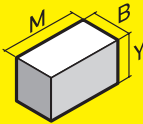
600		Διαστάσεις	Γούρνα	Μοντέλο	Κωδικός	Τιμή €
		Dimensions	Sink	Model	Code	Price €
		(M x B x Y mm)	(M x B mm)			
<b>Χωρίς ράφι - Without lower shelf</b>						
		1800 600 860	400 x 400	LNG3C 18-66	11218066	
		1900 600 860	400 x 400	LNG3C 19-66	11219066	
		2000 600 860	400 x 400	LNG3C 20-66	11220066	
		2100 600 860	400 x 400	LNG3C 21-66	11221066	
		2200 600 860	400 x 400	LNG3C 22-66	11222066	
		2300 600 860	400 x 400	LNG3C 23-66	11223066	
		2400 600 860	400 x 400	LNG3C 24-66	11224066	
<b>Με ράφι - With lower shelf</b>						
		1800 600 860	400 x 400	LNG3CS 18-66	11318066	
		1900 600 860	400 x 400	LNG3CS 19-66	11319066	
		2000 600 860	400 x 400	LNG3CS 20-66	11320066	
		2100 600 860	400 x 400	LNG3CS 21-66	11321066	
		2200 600 860	400 x 400	LNG3CS 22-66	11322066	
		2300 600 860	400 x 400	LNG3CS 23-66	11323066	
		2400 600 860	400 x 400	LNG3CS 24-66	11324066	

Ανοιχτή,  
με 3 γούρνες στο κέντρο  
3 sinks centered,  
open sides on legs



Ανοιχτή,  
με 3 γούρνες αριστερά  
3 sinks on left,  
open sides on legs



<b>Χωρίς ράφι - Without lower shelf</b>						
		2000 600 860	400 x 400	LNG3L 20-66	11420066	
		2100 600 860	400 x 400	LNG3L 21-66	11421066	
		2200 600 860	400 x 400	LNG3L 22-66	11422066	
		2300 600 860	400 x 400	LNG3L 23-66	11423066	
		2400 600 860	400 x 400	LNG3L 24-66	11424066	
		2500 600 860	400 x 400	LNG3L 25-66	11425066	
<b>Με ράφι - With lower shelf</b>						
		2000 600 860	400 x 400	LNG3LS 20-66	11520066	
		2100 600 860	400 x 400	LNG3LS 21-66	11521066	
		2200 600 860	400 x 400	LNG3LS 22-66	11522066	
		2300 600 860	400 x 400	LNG3LS 23-66	11523066	
		2400 600 860	400 x 400	LNG3LS 24-66	11524066	
		2500 600 860	400 x 400	LNG3LS 25-66	11525066	

Ανοιχτή,  
με 3 γούρνες δεξιά  
3 sinks on right,  
open sides on legs



<b>Χωρίς ράφι - Without lower shelf</b>						
		2000 600 860	400 x 400	LNG3R 20-66	11620066	
		2100 600 860	400 x 400	LNG3R 21-66	11621066	
		2200 600 860	400 x 400	LNG3R 22-66	11622066	
		2300 600 860	400 x 400	LNG3R 23-66	11623066	
		2400 600 860	400 x 400	LNG3R 24-66	11624066	
		2500 600 860	400 x 400	LNG3R 25-66	11625066	
<b>Με ράφι - With lower shelf</b>						
		2000 600 860	400 x 400	LNG3RS 20-66	11720066	
		2100 600 860	400 x 400	LNG3RS 21-66	11721066	
		2200 600 860	400 x 400	LNG3RS 22-66	11722066	
		2300 600 860	400 x 400	LNG3RS 23-66	11723066	
		2400 600 860	400 x 400	LNG3RS 24-66	11724066	
		2500 600 860	400 x 400	LNG3RS 25-66	11725066	

# ΛΑΝΤΖΕΣ ΜΕ ΘΕΣΗ ΠΛΥΝΤΗΡΙΟΥ

## SINK UNITS FOR BUILT-IN WASHING UNIT

**600**

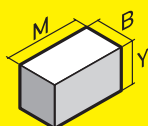

**Διαστάσεις**  
**Dimensions**  
(M x B x Y mm)

**Γούρνα**  
**Sink**  
(M x B mm)

**Μοντέλο**  
**Model**

**Κωδικός**  
**Code**

**Τιμή €**  
**Price €**

**Ανοιχτή,**  
**με 1 γούρνα αριστερά**  
1 sink on left,  
open sides



### Χωρίς ράφι - Without lower shelf

1200	600	860	400 x 400	LNG1LPL 12-64	13012064	
1300	600	860	400 x 400	LNG1LPL 13-64	13013064	
1400	600	860	400 x 400	LNG1LPL 14-64	13014064	
1500	600	860	400 x 400	LNG1LPL 15-64	13015064	

### Με ράφι - With lower shelf

1200	600	860	400 x 400	LNG1LPLS 12-64	13112064	
1300	600	860	400 x 400	LNG1LPLS 13-64	13113064	
1400	600	860	400 x 400	LNG1LPLS 14-64	13114064	
1500	600	860	400 x 400	LNG1LPLS 15-64	13115064	

**Ανοιχτή,**  
**με 1 γούρνα δεξιά**  
1 sink on right,  
open sides



### Χωρίς ράφι - Without lower shelf

1200	600	860	400 x 400	LNG1RPL 12-64	13212064	
1300	600	860	400 x 400	LNG1RPL 13-64	13213064	
1400	600	860	400 x 400	LNG1RPL 14-64	13214064	
1500	600	860	400 x 400	LNG1RPL 15-64	13215064	

### Με ράφι - With lower shelf

1200	600	860	400 x 400	LNG1RPLS 12-64	13312064	
1300	600	860	400 x 400	LNG1RPLS 13-64	13313064	
1400	600	860	400 x 400	LNG1RPLS 14-64	13314064	
1500	600	860	400 x 400	LNG1RPLS 15-64	13315064	

**Ανοιχτή, με 2 γούρνες αριστερά**  
2 sinks on left, open sides



### Χωρίς ράφι - Without lower shelf

1800	600	860	400 x 400	LNG2LPL 18-64	13418064	
1900	600	860	400 x 400	LNG2LPL 19-64	13419064	
2000	600	860	400 x 400	LNG2LPL 20-64	13420064	

### Με ράφι - With lower shelf

1800	600	860	400 x 400	LNG2LPLS 18-64	13518064	
1900	600	860	400 x 400	LNG2LPLS 19-64	13519064	
2000	600	860	400 x 400	LNG2LPLS 20-64	13520064	

**Ανοιχτή, με 2 γούρνες δεξιά**  
2 sinks on right, open sides



### Χωρίς ράφι - Without lower shelf

1800	600	860	400 x 400	LNG2RPL 18-64	13618064	
1900	600	860	400 x 400	LNG2RPL 19-64	13619064	
2000	600	860	400 x 400	LNG2RPL 20-64	13620064	

### Με ράφι - With lower shelf

1800	600	860	400 x 400	LNG2RPLS 18-64	13718064	
1900	600	860	400 x 400	LNG2RPLS 19-64	13719064	
2000	600	860	400 x 400	LNG2RPLS 20-64	13720064	





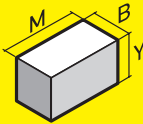
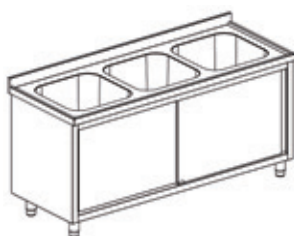

# ΛΑΝΤΖΕΣ ΚΛΕΙΣΤΕΣ

## SINK UNIT ON CUPBOARDS

600		Διαστάσεις	Γούρνα	Μοντέλο	Κωδικός	Τιμή €
		Dimensions	Sink	Model	Code	Price €
		(M x B x Y mm)	(M x B mm)			
<p>Με 3 γούρνες στο κέντρο, με συρόμενες πόρτες</p> <p>3 sinks centered, with sliding doors</p> 		1800 600 860	400 x 400	LKG3C 18-6	12618064	
		1900 600 860	400 x 400	LKG3C 19-6	12619064	
		2000 600 860	400 x 400	LKG3C 20-6	12620064	
		2100 600 860	400 x 400	LKG3C 21-6	12621064	
		2200 600 860	400 x 400	LKG3C 22-6	12622064	
		2300 600 860	400 x 400	LKG3C 23-6	12623064	
		2400 600 860	400 x 400	LKG3C 24-6	12624064	

<p>Με 3 γούρνες αριστερά, με συρόμενες πόρτες</p> <p>3 sinks on left, with sliding doors</p> 		1900 600 860	400 x 400	LKG3L 19-6	12719064		
		2000 600 860	400 x 400	LKG3L 20-6	12720064		
		2100 600 860	400 x 400	LKG3L 21-6	12721064		
		2200 600 860	400 x 400	LKG3L 22-6	12722064		
		2300 600 860	400 x 400	LKG3L 23-6	12723064		
		2400 600 860	400 x 400	LKG3L 24-6	12724064		

<p>Με 3 γούρνες δεξιά, με συρόμενες πόρτες</p> <p>3 sinks on right, with sliding doors</p> 		1900 600 860	400 x 400	LKG3R 19-6	12819064		
		2000 600 860	400 x 400	LKG3R 20-6	12820064		
		2100 600 860	400 x 400	LKG3R 21-6	12821064		
		2200 600 860	400 x 400	LKG3R 22-6	12822064		
		2300 600 860	400 x 400	LKG3R 23-6	12823064		
		2400 600 860	400 x 400	LKG3R 24-6	12824064		

**700**

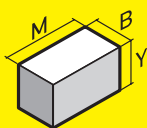

**Ανοιχτή,  
με 1 γούρνα στο κέντρο**  
1 sink centered,  
open sides on legs



Διαστάσεις Dimensions (M x B x Y mm)			Γούρνα Sink (M x B mm)	Μοντέλο Model	Κωδικός Code	Τιμή € Price €
<b>Χωρίς ράφι - Without lower shelf</b>						
700	700	860	500 x 500	LNG1C 7-75	10007075	
800	700	860	500 x 500	LNG1C 8-75	10008075	
900	700	860	500 x 500	LNG1C 9-75	10009075	
1000	700	860	500 x 500	LNG1C 10-75	10010075	
1100	700	860	500 x 500	LNG1C 11-75	10011075	
<b>Με ράφι - With lower shelf</b>						
700	700	860	500 x 500	LNG1CS 7-75	10107075	
800	700	860	500 x 500	LNG1CS 8-75	10108075	
900	700	860	500 x 500	LNG1CS 9-75	10109075	
1000	700	860	500 x 500	LNG1CS 10-75	10110075	
1100	700	860	500 x 500	LNG1CS 11-75	10111075	

**Ανοιχτή,  
με 1 γούρνα αριστερά**  
1 sink on left,  
open sides on legs



<b>Χωρίς ράφι - Without lower shelf</b>						
1200	700	860	500 x 500	LNG1L 12-75	10212075	
1300	700	860	500 x 500	LNG1L 13-75	10213075	
1400	700	860	500 x 500	LNG1L 14-75	10214075	
1500	700	860	500 x 500	LNG1L 15-75	10215075	
1600	700	860	500 x 500	LNG1L 16-75	10216075	
<b>Με ράφι - With lower shelf</b>						
1200	700	860	500 x 500	LNG1LS 12-75	10312075	
1300	700	860	500 x 500	LNG1LS 13-75	10313075	
1400	700	860	500 x 500	LNG1LS 14-75	10314075	
1500	700	860	500 x 500	LNG1LS 15-75	10315075	
1600	700	860	500 x 500	LNG1LS 16-75	10316075	

**Ανοιχτή,  
με 1 γούρνα δεξιά**  
1 sink on right,  
open sides on legs



<b>Χωρίς ράφι - Without lower shelf</b>						
1200	700	860	500 x 500	LNG1R 12-75	10412075	
1300	700	860	500 x 500	LNG1R 13-75	10413075	
1400	700	860	500 x 500	LNG1R 14-75	10414075	
1500	700	860	500 x 500	LNG1R 15-75	10415075	
1600	700	860	500 x 500	LNG1R 16-75	10416075	
<b>Με ράφι - With lower shelf</b>						
1200	700	860	500 x 500	LNG1RS 12-75	10512075	
1300	700	860	500 x 500	LNG1RS 13-75	10513075	
1400	700	860	500 x 500	LNG1RS 14-75	10514075	
1500	700	860	500 x 500	LNG1RS 15-75	10515075	
1600	700	860	500 x 500	LNG1RS 16-75	10516075	

**700**

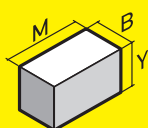

**Διαστάσεις**  
**Dimensions**

(M x B x Y mm)

**Γούρνα**  
**Sink**

(M x B mm)

**Μοντέλο**  
**Model**

**Κωδικός**  
**Code**

**Τιμή €**  
**Price €**

**Ανοιχτή,**  
**με 2 γούρνες στο κέντρο**  
2 sinks centered,  
open sides on legs



**Χωρίς ράφι - Without lower shelf**

1000	700	860	500 x 400	LNG2C 10-75	10610075	
1100	700	860	500 x 400	LNG2C 11-75	10611075	
1200	700	860	500 x 500	LNG2C 12-75	10612075	
1500	700	860	500 x 500	LNG2C 15-75	10615075	
1600	700	860	500 x 500	LNG2C 16-75	10616075	

**Με ράφι - With lower shelf**

1000	700	860	500 x 400	LNG2CS 10-75	10710075	
1100	700	860	500 x 400	LNG2CS 11-75	10711075	
1200	700	860	500 x 500	LNG2CS 12-75	10712075	
1500	700	860	500 x 500	LNG2CS 15-75	10715075	
1600	700	860	500 x 500	LNG2CS 16-75	10716075	

**Ανοιχτή,**  
**με 2 γούρνες αριστερά**  
2 sinks on left,  
open sides on legs

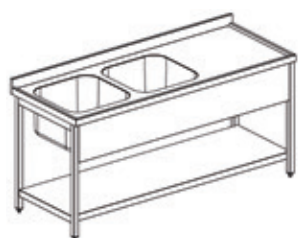

**Χωρίς ράφι - Without lower shelf**

1400	700	860	500 x 500	LNG2L 14-75	10814075	
1500	700	860	500 x 500	LNG2L 15-75	10815075	
1600	700	860	500 x 500	LNG2L 16-75	10816075	
1700	700	860	500 x 500	LNG2L 17-75	10817075	
1800	700	860	500 x 500	LNG2L 18-75	10818075	
1900	700	860	500 x 500	LNG2L 19-75	10819075	
2000	700	860	500 x 500	LNG2L 20-75	10820075	

**Με ράφι - With lower shelf**

1400	700	860	500 x 500	LNG2LS 14-75	10914075	
1500	700	860	500 x 500	LNG2LS 15-75	10915075	
1600	700	860	500 x 500	LNG2LS 16-75	10916075	
1700	700	860	500 x 500	LNG2LS 17-75	10917075	
1800	700	860	500 x 500	LNG2LS 18-75	10918075	
1900	700	860	500 x 500	LNG2LS 19-75	10919075	
2000	700	860	500 x 500	LNG2LS 20-75	10920075	

**Ανοιχτή,**  
**με 2 γούρνες δεξιά**  
2 sinks on right,  
open sides on legs

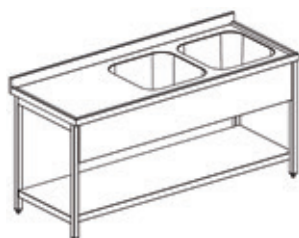

**Χωρίς ράφι - Without lower shelf**

1400	700	860	500 x 500	LNG2R 14-75	11014075	
1500	700	860	500 x 500	LNG2R 15-75	11015075	
1600	700	860	500 x 500	LNG2R 16-75	11016075	
1700	700	860	500 x 500	LNG2R 17-75	11017075	
1800	700	860	500 x 500	LNG2R 18-75	11018075	
1900	700	860	500 x 500	LNG2R 19-75	11019075	
2000	700	860	500 x 500	LNG2R 20-75	11020075	

**Με ράφι - With lower shelf**

1400	700	860	500 x 500	LNG2RS 14-75	11114075	
1500	700	860	500 x 500	LNG2RS 15-75	11115075	
1600	700	860	500 x 500	LNG2RS 16-75	11116075	
1700	700	860	500 x 500	LNG2RS 17-75	11117075	
1800	700	860	500 x 500	LNG2RS 18-75	11118075	
1900	700	860	500 x 500	LNG2RS 19-75	11119075	
2000	700	860	500 x 500	LNG2RS 20-75	11120075	

**700**

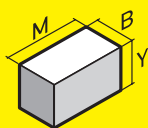

**Διαστάσεις**  
**Dimensions**

(M x B x Y mm)

**Γούρνα**  
**Sink**

(M x B mm)

**Μοντέλο**  
**Model**

**Κωδικός**  
**Code**

**Τιμή €**  
**Price €**

**Ανοιχτή,**  
**με 3 γούρνες στο κέντρο**  
3 sinks centered,  
open sides on legs

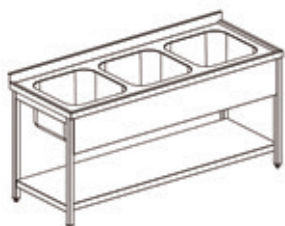

**Χωρίς ράφι - Without lower shelf**

1800	700	860	500 x 500	LNG3C 18-75	11218075	
1900	700	860	500 x 500	LNG3C 19-75	11219075	
2000	700	860	500 x 500	LNG3C 20-75	11220075	
2100	700	860	500 x 500	LNG3C 21-75	11221075	
2200	700	860	500 x 500	LNG3C 22-75	11222075	
2300	700	860	500 x 500	LNG3C 23-75	11223075	
2400	700	860	500 x 500	LNG3C 24-75	11224075	

**Με ράφι - With lower shelf**

1800	700	860	500 x 500	LNG3CS 18-75	11318075	
1900	700	860	500 x 500	LNG3CS 19-75	11319075	
2000	700	860	500 x 500	LNG3CS 20-75	11320075	
2100	700	860	500 x 500	LNG3CS 21-75	11321075	
2200	700	860	500 x 500	LNG3CS 22-75	11322075	
2300	700	860	500 x 500	LNG3CS 23-75	11323075	
2400	700	860	500 x 500	LNG3CS 24-75	11324075	

**Ανοιχτή,**  
**με 3 γούρνες αριστερά**  
3 sinks on left,  
open sides on legs



**Χωρίς ράφι - Without lower shelf**

2000	700	860	500 x 500	LNG3L 20-75	11420075	
2100	700	860	500 x 500	LNG3L 21-75	11421075	
2200	700	860	500 x 500	LNG3L 22-75	11422075	
2300	700	860	500 x 500	LNG3L 23-75	11423075	
2400	700	860	500 x 500	LNG3L 24-75	11424075	
2500	700	860	500 x 500	LNG3L 25-75	11425075	

**Με ράφι - With lower shelf**

2000	700	860	500 x 500	LNG3LS 20-75	11520075	
2100	700	860	500 x 500	LNG3LS 21-75	11521075	
2200	700	860	500 x 500	LNG3LS 22-75	11522075	
2300	700	860	500 x 500	LNG3LS 23-75	11523075	
2400	700	860	500 x 500	LNG3LS 24-75	11524075	
2500	700	860	500 x 500	LNG3LS 25-75	11525075	

**Ανοιχτή,**  
**με 3 γούρνες δεξιά**  
3 sinks on right,  
open sides on legs



**Χωρίς ράφι - Without lower shelf**

2000	700	860	500 x 500	LNG3R 20-75	11620075	
2100	700	860	500 x 500	LNG3R 21-75	11621075	
2200	700	860	500 x 500	LNG3R 22-75	11622075	
2300	700	860	500 x 500	LNG3R 23-75	11623075	
2400	700	860	500 x 500	LNG3R 24-75	11624075	
2500	700	860	500 x 500	LNG3R 25-75	11625075	

**Με ράφι - With lower shelf**

2000	700	860	500 x 500	LNG3RS 20-75	11720075	
2100	700	860	500 x 500	LNG3RS 21-75	11721075	
2200	700	860	500 x 500	LNG3RS 22-75	11722075	
2300	700	860	500 x 500	LNG3RS 23-75	11723075	
2400	700	860	500 x 500	LNG3RS 24-75	11724075	
2500	700	860	500 x 500	LNG3RS 25-75	11725075	

# ΛΑΝΤΖΕΣ ΜΕ ΘΕΣΗ ΠΛΥΝΤΗΡΙΟΥ

## SINK UNITS FOR BUILT-IN WASHING UNIT

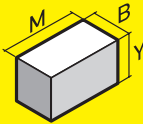
700		Διαστάσεις	Γούρνα	Μοντέλο	Κωδικός	Τιμή €
		Dimensions	Sink	Model	Code	Price €
		(M x B x Y mm)	(M x B mm)			
<b>Ανοιχτή, με 1 γούρνα αριστερά</b> 1 sink on left, open sides						
<b>Χωρίς ράφι - Without lower shelf</b>						
1200	700	860	500 x 500	LNG1LPL 12-75	13012075	
1300	700	860	500 x 500	LNG1LPL 13-75	13013075	
1400	700	860	500 x 500	LNG1LPL 14-75	13014075	
1500	700	860	500 x 500	LNG1LPL 15-75	13015075	
<b>Με ράφι - With lower shelf</b>						
1200	700	860	500 x 500	LNG1LPLS 12-75	13112075	
1300	700	860	500 x 500	LNG1LPLS 13-75	13113075	
1400	700	860	500 x 500	LNG1LPLS 14-75	13114075	
1500	700	860	500 x 500	LNG1LPLS 15-75	13115075	

**Ανοιχτή, με 1 γούρνα δεξιά**  
1 sink on right, open sides



<b>Χωρίς ράφι - Without lower shelf</b>						
1200	700	860	500 x 500	LNG1RPL 12-75	13212075	
1300	700	860	500 x 500	LNG1RPL 13-75	13213075	
1400	700	860	500 x 500	LNG1RPL 14-75	13214075	
1500	700	860	500 x 500	LNG1RPL 15-75	13215075	
<b>Με ράφι - With lower shelf</b>						
1200	700	860	500 x 500	LNG1RPLS 12-75	13312075	
1300	700	860	500 x 500	LNG1RPLS 13-75	13313075	
1400	700	860	500 x 500	LNG1RPLS 14-75	13314075	
1500	700	860	500 x 500	LNG1RPLS 15-75	13315075	

**Ανοιχτή, με 2 γούρνες αριστερά**  
2 sinks on left, open sides





<b>Χωρίς ράφι - Without lower shelf</b>						
1800	700	860	500 x 500	LNG2LPL 18-75	13418075	
1900	700	860	500 x 500	LNG2LPL 19-75	13419075	
2000	700	860	500 x 500	LNG2LPL 20-75	13420075	
2100	700	860	500 x 500	LNG2LPL 21-75	13421075	
<b>Με ράφι - With lower shelf</b>						
1800	700	860	500 x 500	LNG2LPLS 18-75	13518075	
1900	700	860	500 x 500	LNG2LPLS 19-75	13519075	
2000	700	860	500 x 500	LNG2LPLS 20-75	13520075	
2100	700	860	500 x 500	LNG2LPLS 21-75	13521075	

**Ανοιχτή, με 2 γούρνες δεξιά**  
2 sinks on right, open sides

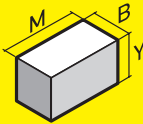

<b>Χωρίς ράφι - Without lower shelf</b>						
1800	700	860	500 x 500	LNG2RPL 18-75	13618075	
1900	700	860	500 x 500	LNG2RPL 19-75	13619075	
2000	700	860	500 x 500	LNG2RPL 20-75	13620075	
2100	700	860	500 x 500	LNG2RPL 21-75	13621075	
<b>Με ράφι - With lower shelf</b>						
1800	700	860	500 x 500	LNG2RPLS 18-75	13718075	
1900	700	860	500 x 500	LNG2RPLS 19-75	13719075	
2000	700	860	500 x 500	LNG2RPLS 20-75	13720075	
2100	700	860	500 x 500	LNG2RPLS 21-75	13721075	

700		Διαστάσεις	Γούρνα	Μοντέλο	Κωδικός	Τιμή €
		Dimensions	Sink	Model	Code	Price €
		(M x B x Y mm)	(M x B mm)			
Με 1 γούρνα στο κέντρο, με ανοιγόμενη πόρτα 1 sink centered, with hinged door		700 700 860	500 x 500	LKG1C 7-75	12007075	
		800 700 860	500 x 500	LKG1C 8-75*	12008075	
		900 700 860	500 x 500	LKG1C 9-75*	12009075	
  * 2 πόρτες - 2 doors						

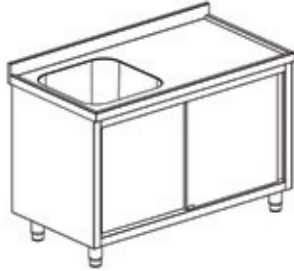
Με 1 γούρνα αριστερά, με συρόμενες πόρτες 1 sink on left, with sliding doors		1000 700 860	500 x 500	LKG1L 10-75	12110075	
		1100 700 860	500 x 500	LKG1L 11-75	12111075	
		1200 700 860	500 x 500	LKG1L 12-75	12112075	
		1300 700 860	500 x 500	LKG1L 13-75	12113075	
		1400 700 860	500 x 500	LKG1L 14-75	12114075	
		1500 700 860	500 x 500	LKG1L 15-75	12115075	
		1600 700 860	500 x 500	LKG1L 16-75	12116075	
		1700 700 860	500 x 500	LKG1L 17-75	12117075	
		1800 700 860	500 x 500	LKG1L 18-75	12118075	
		1900 700 860	500 x 500	LKG1L 19-75	12119075	
		2000 700 860	500 x 500	LKG1L 20-75	12120075	
		2100 700 860	500 x 500	LKG1L 21-75	12121075	
		2200 700 860	500 x 500	LKG1L 22-75	12122075	
						

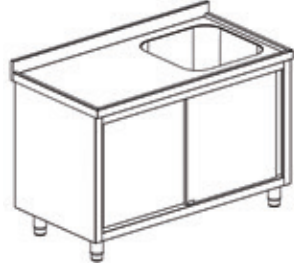

Με 1 γούρνα δεξιά, με συρόμενες πόρτες 1 sink on right, with sliding doors		1000 700 860	500 x 500	LKG1R 10-75	12210075	
		1100 700 860	500 x 500	LKG1R 11-75	12211075	
		1200 700 860	500 x 500	LKG1R 12-75	12212075	
		1300 700 860	500 x 500	LKG1R 13-75	12213075	
		1400 700 860	500 x 500	LKG1R 14-75	12214075	
		1500 700 860	500 x 500	LKG1R 15-75	12215075	
		1600 700 860	500 x 500	LKG1R 16-75	12216075	
		1700 700 860	500 x 500	LKG1R 17-75	12217075	
		1800 700 860	500 x 500	LKG1R 18-75	12218075	
		1900 700 860	500 x 500	LKG1R 19-75	12219075	
		2000 700 860	500 x 500	LKG1R 20-75	12220075	
		2100 700 860	500 x 500	LKG1R 21-75	12221075	
		2200 700 860	500 x 500	LKG1R 22-75	12222075	
						





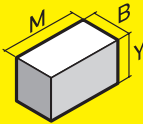

# ΛΑΝΤΖΕΣ ΚΛΕΙΣΤΕΣ ΜΕ ΘΕΣΗ ΠΛΥΝΤΗΡΙΟΥ

## SINK UNITS ON CUPBOARD FOR BUILT-IN WASHING UNIT



700		Διαστάσεις	Γούρνα	Μοντέλο	Κωδικός	Τιμή €
		Dimensions	Sink	Model	Code	Price €
		(M x B x Y mm)	(M x B mm)			
Κλειστή, με 1 γούρνα αριστερά & ανοιγόμενη πόρτα 1 sink on left & hinged door		1200 700 860	500 x 500	LKG1LPL 12-75	13812075	
		1300 700 860	500 x 500	LKG1LPL 13-75	13813075	
		1400 700 860	500 x 500	LKG1LPL 14-75	13814075	
		1500 700 860	500 x 500	LKG1LPL 15-75	13815075	

Κλειστή, με 1 γούρνα δεξιά & ανοιγόμενη πόρτα 1 sink on right & hinged door		1200 700 860	500 x 500	LKG1RPL 12-75	13912075	
		1300 700 860	500 x 500	LKG1RPL 13-75	13913075	
		1400 700 860	500 x 500	LKG1RPL 14-75	13914075	
		1500 700 860	500 x 500	LKG1RPL 15-75	13915075	

Κλειστή, με 2 γούρνες αριστερά & συρόμενες πόρτες 2 sinks on left & sliding doors		1800 700 860	500 x 500	LKG2LPL 18-75	14018075	
		1900 700 860	500 x 500	LKG2LPL 19-75	14019075	
		2000 700 860	500 x 500	LKG2LPL 20-75	14020075	
		2100 700 860	500 x 500	LKG2LPL 21-75	14021075	

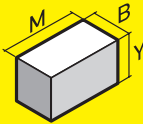
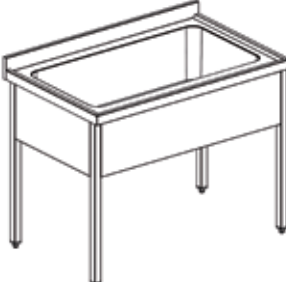
Κλειστή, με 2 γούρνες δεξιά & συρόμενες πόρτες 2 sinks on right & sliding doors		1800 700 860	500 x 500	LKG2RPL 18-75	14118075	
		1900 700 860	500 x 500	LKG2RPL 19-75	14119075	
		2000 700 860	500 x 500	LKG2RPL 20-75	14120075	
		2100 700 860	500 x 500	LKG2RPL 21-75	14121075	

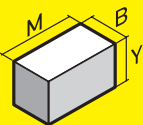
700		Διαστάσεις	Γούρνα	Μοντέλο	Κωδικός	Τιμή €
		Dimensions	Sink	Model	Code	Price €
		(M x B x Y mm)	(M x B mm)			
<p>Λάτζα σκευών ανοιχτή, με 1 κεντρική γούρνα</p> <p>Pot sink unit, with 1 centered sink</p> 		1000 700 860	960 x 500	LNG1C 10-79	14210079	
		1100 700 860	960 x 500	LNG1C 11-79	14211079	
		1200 700 860	960 x 500	LNG1C 12-79	14212079	
		1300 700 860	960 x 500	LNG1C 13-79	14213079	
		1400 700 860	960 x 500	LNG1C 14-79	14214079	
		1500 700 860	960 x 500	LNG1C 15-79	14215079	
		1600 700 860	960 x 500	LNG1C 16-79	14216079	
		1700 700 860	960 x 500	LNG1C 17-79	14217079	
		1800 700 860	960 x 500	LNG1C 18-79	14218079	

700		Διαστάσεις	Γούρνα	Μοντέλο	Κωδικός	Τιμή €
		Dimensions	Sink	Model	Code	Price €
		(M x B x Y mm)	(M x B mm)			
<p>Λάτζα σκευών κλειστή, με 1 κεντρική γούρνα &amp; συρόμενες πόρτες</p> <p>Pot sink unit, with 1 centered sink &amp; sliding doors</p> 		1000 700 860	960 x 500	LKG1C 10-79	14510079	
		1100 700 860	960 x 500	LKG1C 11-79	14511079	
		1200 700 860	960 x 500	LKG1C 12-79	14512079	
		1300 700 860	960 x 500	LKG1C 13-79	14513079	
		1400 700 860	960 x 500	LKG1C 14-79	14514079	
		1500 700 860	960 x 500	LKG1C 15-79	14515079	
		1600 700 860	960 x 500	LKG1C 16-79	14516079	
		1700 700 860	960 x 500	LKG1C 17-79	14517079	
		1800 700 860	960 x 500	LKG1C 18-79	14518079	

	Διαστάσεις Dimensions (M x B x Y mm)	Μοντέλο Model	Κωδικός Code	Τιμή € Price €
--	--	------------------	-----------------	-------------------

**Βρύση μιας οπής**  
 1-hole level water mixer

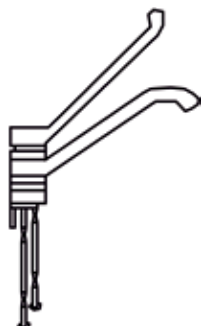

		VRS	83000000	
--	--	-----	----------	--

	Διαστάσεις Dimensions (M x B x Y mm)	Μοντέλο Model	Κωδικός Code	Τιμή € Price €
--	--	------------------	-----------------	-------------------

**Καταιωνιστήρας μιας οπής και βρύση**  
 1-hole shower with level water mixer



		SHWVRS	84000000	
--	--	--------	----------	--

	Διαστάσεις Dimensions (M x B x Y mm)	Μοντέλο Model	Κωδικός Code	Τιμή € Price €
--	--	------------------	-----------------	-------------------

**Βρύση**  
 Tap



		VRS-CLAS	82000000	
--	--	----------	----------	--

	Διαστάσεις Dimensions (M x B x Y mm)	Μοντέλο Model	Κωδικός Code	Τιμή € Price €
<b>Ποδοβαλβίδα</b> Foot operating mixer tap		PDVLV	86000000	

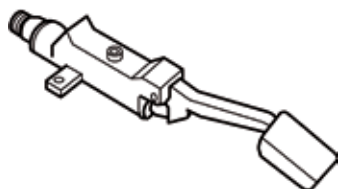

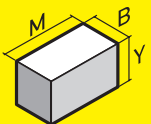
	Διαστάσεις Dimensions (M x B x Y mm)	Μοντέλο Model	Volt / Watt	Κωδικός Code	Τιμή € Price €
---	--	------------------	-------------	-----------------	-------------------

**Χημικό πλυντήριο μονοφασικό**  
Cooking vessel laundry  
single-phase

800	500	880
1050	500	880

XMP 8-5
XMP 10-5

220 / 3000
220 / 3000

14980050
14910550

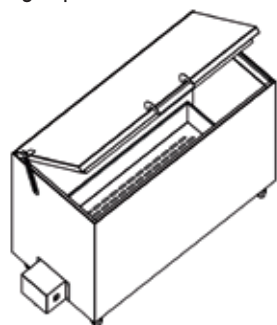

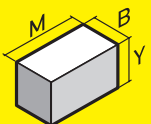
	Διαστάσεις Dimensions (M x B x Y mm)	Μοντέλο Model	Λίτρα Liter	Κωδικός Code	Τιμή € Price €
---	--	------------------	----------------	-----------------	-------------------

**Λιποσυλλέκτης**  
Grease filters



340	225	251
550	400	251

LPSSML 3-2
LPSLRG 5-4

19
55

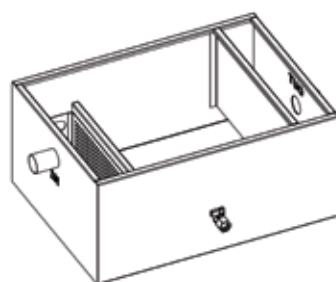
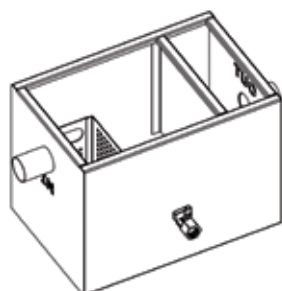
15034022
15155040

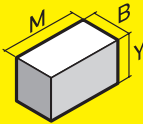



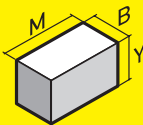

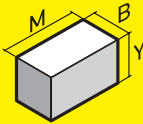
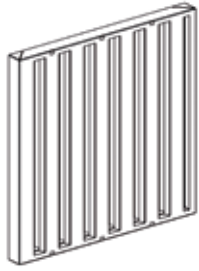
900		Διαστάσεις Dimensions (M x B x Y mm)	AISI 430			AISI 304			
			Μοντέλο Model	Κωδικός Code	Τιμή € Price €	Μοντέλο Model	Κωδικός Code	Τιμή € Price €	
<b>Φούσκα τοίχου λοξή</b> Wall mounted angled type  	1000	900	500	TOL430 10-5	16010090		TOL304 10-5	16110090	
	1500	900	500	TOL430 15-5	16015090		TOL304 15-5	16115090	
	2000	900	500	TOL430 20-5	16020090		TOL304 20-5	16120090	
	2500	900	500	TOL430 25-5	16025090		TOL304 25-5	16125090	
	3000	900	500	TOL430 30-5	16030090		TOL304 30-5	16130090	
	3500	900	500	TOL430 35-5	16035090		TOL304 35-5	16135090	
	4000	900	500	TOL430 40-5	16040090		TOL304 40-5	16140090	

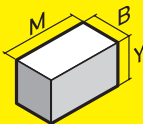
900		Διαστάσεις Dimensions (M x B x Y mm)	AISI 430			AISI 304			
			Μοντέλο Model	Κωδικός Code	Τιμή € Price €	Μοντέλο Model	Κωδικός Code	Τιμή € Price €	
<b>Φούσκα τοίχου τετράγωνη</b> Range hood squared type  	1000	900	500	TOP430 10-5	16210090		TOP304 10-5	16310090	
	1500	900	500	TOP430 15-5	16215090		TOP304 15-5	16315090	
	2000	900	500	TOP430 20-5	16220090		TOP304 20-5	16320090	
	2500	900	500	TOP430 25-5	16225090		TOP304 25-5	16325090	
	3000	900	500	TOP430 30-5	16230090		TOP304 30-5	16330090	
	3500	900	500	TOP430 35-5	16235090		TOP304 35-5	16335090	
	4000	900	500	TOP430 40-5	16240090		TOP304 40-5	16340090	

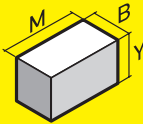
	Διαστάσεις Dimensions (M x B x Y mm)	AISI 430			AISI 304				
		Μοντέλο Model	Κωδικός Code	Τιμή € Price €	Μοντέλο Model	Κωδικός Code	Τιμή € Price €		
<b>Φίλτρο Φούσκα</b> Filters  	500	500	40	FIL430 5-5	18050050		FIL304 5-5	18150050	

	Τύπος Type	Watt	Kelvin	Μοντέλο Model	Κωδικός Code	Τιμή € Price €
	HALOGEN	80	2800	ALG 80	18380280	

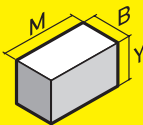
750		Διαστάσεις Dimensions (M x B x Y mm)	AISI 430			AISI 304		
			Μοντέλο Model	Κωδικός Code	Τιμή € Price €	Μοντέλο Model	Κωδικός Code	Τιμή € Price €
Φούσκα τοίχου snack Wall mounted snack type		1000 750 500	TOS430 10-5	16410075		TOS304 10-5	16510075	
		1500 750 500	TOS430 15-5	16415075		TOS304 15-5	16515075	
		2000 750 500	TOS430 20-5	16420075		TOS304 20-5	16520075	
		2500 750 500	TOS430 25-5	16425075		TOS304 25-5	16525075	
		3000 750 500	TOS430 30-5	16430075		TOS304 30-5	16530075	
		3500 750 500	TOS430 35-5	16435075		TOS304 35-5	16535075	
		4000 750 500	TOS430 40-5	16440075		TOS304 40-5	16540075	

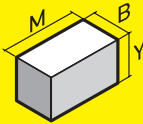

2200		Διαστάσεις Dimensions (M x B x Y mm)	AISI 430			AISI 304		
			Μοντέλο Model	Κωδικός Code	Τιμή € Price €	Μοντέλο Model	Κωδικός Code	Τιμή € Price €
Φούσκα κέντρου snack Central snack type		1500 2200 500	KES430 15-22	16615022		KES304 15-22	16715022	
		1750 2200 500	KES430 17-22	16617522		KES304 17-22	16717522	
		2000 2200 500	KES430 20-22	16620022		KES304 20-22	16720022	
		2500 2200 500	KES430 25-22	16625022		KES304 25-22	16725022	
		3000 2200 500	KES430 30-22	16630022		KES304 30-22	16730022	
		3500 2200 500	KES430 35-22	16635022		KES304 35-22	16735022	
		4000 2200 500	KES430 40-22	16640022		KES304 40-22	16740022	

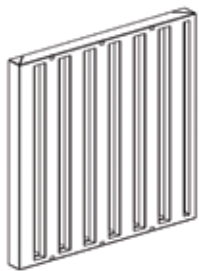

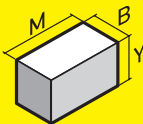
	Διαστάσεις Dimensions (M x B x Y mm)	AISI 430			AISI 304		
		Μοντέλο Model	Κωδικός Code	Τιμή € Price €	Μοντέλο Model	Κωδικός Code	Τιμή € Price €
Φίλτρο Φούσκας Filters	500 500 40	FIL430 5-5	18050050		FIL304 5-5	18150050	

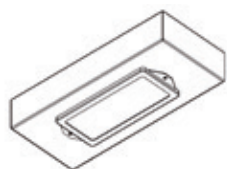

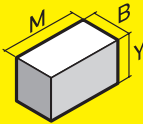
	Τύπος Type	Watt	Kelvin	Μοντέλο Model	Κωδικός Code	Τιμή € Price €
	HALOGEN	80	2800	ALG 80	18380280	



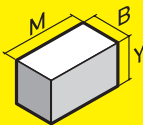

1800 	Διαστάσεις Dimensions (M x B x Y mm)	AISI 430			AISI 304		
		Μοντέλο Model	Κωδικός Code	Τιμή € Price €	Μοντέλο Model	Κωδικός Code	Τιμή € Price €
<b>Φούσκα κέντρου τετράγωνη</b> Central squared type 	2000 1800 500	KEP430 20-18	16620018		KEP304 20-18	16720018	
	2500 1800 500	KEP430 25-18	16625018		KEP304 25-18	16725018	
	3000 1800 500	KEP430 30-18	16630018		KEP304 30-18	16730018	
	3500 1800 500	KEP430 35-18	16635018		KEP304 35-18	16735018	
	4000 1800 500	KEP430 40-18	16640018		KEP304 40-18	16740018	
	4500 1800 500	KEP430 45-18	16645018		KEP304 45-18	16745018	
	5000 1800 500	KEP430 50-18	16650018		KEP304 50-18	16750018	

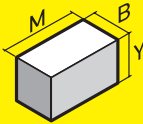
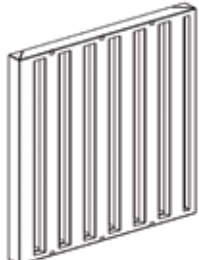
2200 	Διαστάσεις Dimensions (M x B x Y mm)	AISI 430			AISI 304		
		Μοντέλο Model	Κωδικός Code	Τιμή € Price €	Μοντέλο Model	Κωδικός Code	Τιμή € Price €
<b>Φούσκα κέντρου τετράγωνη</b> Central squared type 	2000 2200 500	KEP430 20-22	16820022		KEP304 20-22	16920022	
	2500 2200 500	KEP430 25-22	16825022		KEP304 25-22	16925022	
	3000 2200 500	KEP430 30-22	16830022		KEP304 30-22	16930022	
	3500 2200 500	KEP430 35-22	16835022		KEP304 35-22	16935022	
	4000 2200 500	KEP430 40-22	16840022		KEP304 40-22	16940022	
	4500 2200 500	KEP430 45-22	16845022		KEP304 45-22	16945022	
	5000 2200 500	KEP430 50-22	16850022		KEP304 50-22	16950022	

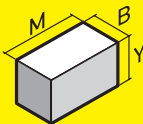
	Διαστάσεις Dimensions (M x B x Y mm)	AISI 430			AISI 304		
		Μοντέλο Model	Κωδικός Code	Τιμή € Price €	Μοντέλο Model	Κωδικός Code	Τιμή € Price €
<b>Φίλτρο Φούσκας</b> Filters 	500 500 40	FIL430 5-5	18050050		FIL304 5-5	18150050	

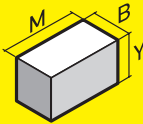
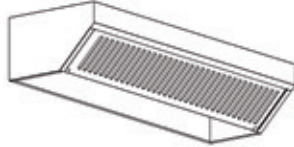

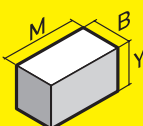
	Τύπος Type	Watt	Kelvin	Μοντέλο Model	Κωδικός Code	Τιμή € Price €
	HALOGEN	80	2800	ALG 80	18380280	

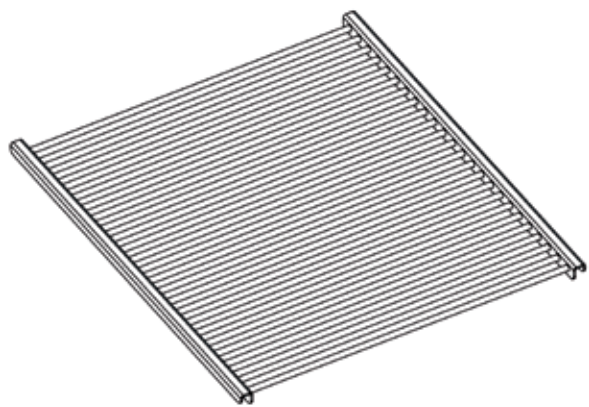

1200		<b>Διαστάσεις Dimensions</b> (M x B x Y mm)	AISI 430			AISI 304		
			Μοντέλο Model	Κωδικός Code	Τιμή € Price €	Μοντέλο Model	Κωδικός Code	Τιμή € Price €
Φούσκα Φούρνου Range hood for oven		1000 1200 300	TOF430 10-12	17010012	520,00	TOF304 10-12	17110012	

500		<b>Διαστάσεις Dimensions</b> (M x B x Y mm)	Μοντέλο Model	Κωδικός Code	Τιμή € Price €
			Επιτραπέζια ψησταριά Grill on table		1000 500 270
		1200 500 270	KRVEP 12-5	19012050	
		1800 500 270	KRVEP 18-5	19018050	
		2000 500 270	KRVEP 20-5	19020050	

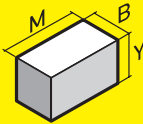
Σχάρες INOX Rack INOX	
	
Διαστάσεις Ψησταριάς - Grill Dimensions	Τιμή - Price €/m <sup>3</sup>
1000	
1200	
1800	
2000	

Πυρότουβλο Fire brick	
	
Διαστάσεις Ψησταριάς - Grill Dimensions	Τιμή - Price €
1000 500 270	
1200 500 270	
1800 500 270	
2000 500 270	

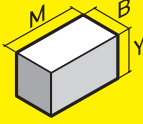
700		Διαστάσεις Dimensions (M x B x Y mm)	Θέσεις GN	ΧΩΡΙΣ ΒΙΤΡΙΝΑ WITHOUT SHOWCASE			ΜΕ ΒΙΤΡΙΝΑ WITH SHOWCASE		
				Μοντέλο Model	Κωδικός Code	Τιμή € Price €	Μοντέλο Model	Κωδικός Code	Τιμή € Price €
Μπεν μαρί επιτραπέζιο με λάμπες αλογόνου Bain marie on table with halogen lights		1080 700 260	3 x 1/1	BMREPX 10-7	25010870		BMREPM 10-7	25110870	
		1400 700 260	4 x 1/1	BMREPX 14-7	25014070		BMREPM 14-7	25114070	
		1730 700 260	5 x 1/1	BMREPX 17-7	25017370		BMREPM 17-7	25117370	
		2050 700 260	6 x 1/1	BMREPX 20-7	25020570		BMREPM 20-7	25120570	
									

700		Διαστάσεις Dimensions (M x B x Y mm)	Θέσεις GN	ΧΩΡΙΣ ΒΙΤΡΙΝΑ WITHOUT SHOWCASE			ΜΕ ΒΙΤΡΙΝΑ WITH SHOWCASE		
				Μοντέλο Model	Κωδικός Code	Τιμή € Price €	Μοντέλο Model	Κωδικός Code	Τιμή € Price €
Μπεν μαρί επιδαπέδιο με συρόμενες πόρτες και λάμπες αλογόνου Bain marie cupboard with sliding doors and halogen lights		1080 700 860	3 x 1/1	BMREDX 10-7	25210870		BMREDM 10-7	25310870	
		1400 700 860	4 x 1/1	BMREDX 14-7	25214070		BMREDM 14-7	25314070	
		1730 700 860	5 x 1/1	BMREDX 17-7	25217370		BMREDM 17-7	25317370	
		2050 700 860	6 x 1/1	BMREDX 20-7	25220570		BMREDM 20-7	25320570	
									











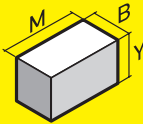
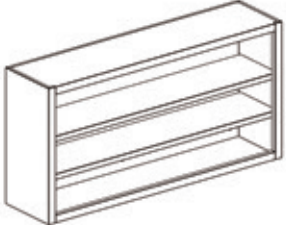

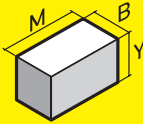
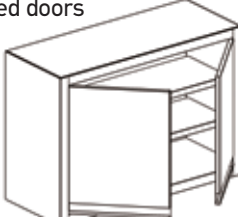
340		Διαστάσεις	Μοντέλο	Κωδικός	Τιμή €
		Dimensions			
		(M x B x Y mm)	Model	Code	Price €
Ανοιχτή Open		600 340 720	PTRO 3-6	20006034	
		700 340 720	PTRO 3-7	20007034	
		800 340 720	PTRO 3-8	20008034	
		900 340 720	PTRO 3-9	20009034	
		1000 340 720	PTRO 3-10	20010034	
		1100 340 720	PTRO 3-11	20011034	
		1200 340 720	PTRO 3-12	20012034	
		1300 340 720	PTRO 3-13	20013034	
		1400 340 720	PTRO 3-14	20014034	
		1500 340 720	PTRO 3-15	20015034	
		1600 340 720	PTRO 3-16	20016034	
1700 340 720	PTRO 3-17	20017034			
1800 340 720	PTRO 3-18	20018034			
1900 340 720	PTRO 3-19	20019034			

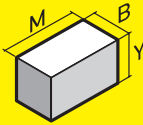
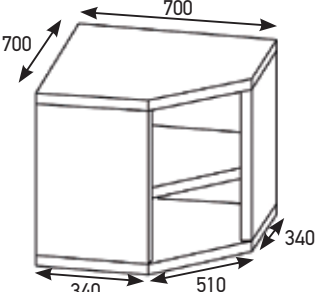
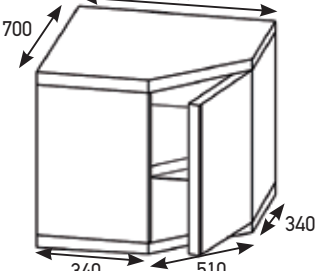
400		Διαστάσεις	Μοντέλο	Κωδικός	Τιμή €	
		Dimensions				
		(M x B x Y mm)	Model	Code	Price €	
Ανοιγόμενες πόρτες Hinged doors		400 400 720	PTR1A 4-4	20104040		
		500 400 720	PTR1A 5-4	20105040		
		600 400 720	PTR1A 6-4	20106040		
		<b>Με 2 πόρτες - With 2 doors</b>				
		700 400 720	PTR2A 7-4	20107040		
		800 400 720	PTR2A 8-4	20108040		
		900 400 720	PTR2A 9-4	20109040		

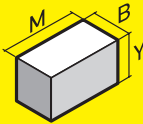
700		Διαστάσεις	Μοντέλο	Κωδικός	Τιμή €
		Dimensions			
		(M x B x Y mm)	Model	Code	Price €
	<b>Ανοιχτή, γωνιακή - Open, corner type</b>				
	700 700 720	PTRG 7-7	20207070		
	<b>Γωνιακή, με ανοιγόμενη πόρτα - Corner type with hinged door</b>				
	700 700 720	PTRGA 7-7	20307070		

340		Διαστάσεις	Μοντέλο	Κωδικός	Τιμή €
		Dimensions			
		(M x B x Y mm)	Model	Code	Price €
<b>Με συρόμενες πόρτες τζαμιού</b> With glass sliding doors		1000 340 720	PTRG 10-4	20410034	
		1100 340 720	PTRG 11-4	20411034	
		1200 340 720	PTRG 12-4	20412034	
		1300 340 720	PTRG 13-4	20413034	
		1400 340 720	PTRG 14-4	20414034	
		1500 340 720	PTRG 15-4	20415034	
		1600 340 720	PTRG 16-4	20416034	
		1700 340 720	PTRG 17-4	20417034	
		1800 340 720	PTRG 18-4	20418034	
		1900 340 720	PTRG 19-4	20419034	

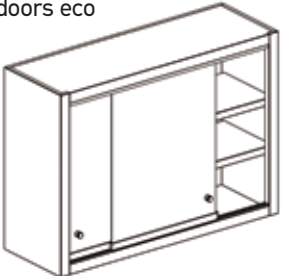
<b>Με συρόμενες μεταλλικές πόρτες eco</b> With metallic sliding doors eco		1000 340 720	PTRSECO 10-3	20510034	
		1100 340 720	PTRSECO 11-3	20511034	
		1200 340 720	PTRSECO 12-3	20512034	
		1300 340 720	PTRSECO 13-3	20513034	
		1400 340 720	PTRSECO 14-3	20514034	
		1500 340 720	PTRSECO 15-3	20515034	
		1600 340 720	PTRSECO 16-3	20516034	
		1700 340 720	PTRSECO 17-3	20517034	
		1800 340 720	PTRSECO 18-3	20518034	
		1900 340 720	PTRSECO 19-3	20519034	

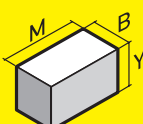
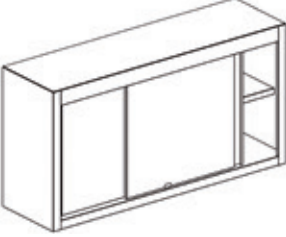
400		Διαστάσεις	Μοντέλο	Κωδικός	Τιμή €
		Dimensions			
		(M x B x Y mm)	Model	Code	Price €
<b>Με συρόμενες μεταλλικές πόρτες INOX</b> With metallic sliding doors INOX		1000 400 720	PTRS 10-4	20610040	
		1100 400 720	PTRS 11-4	20611040	
		1200 400 720	PTRS 12-4	20612040	
		1300 400 720	PTRS 13-4	20613040	
		1400 400 720	PTRS 14-4	20614040	
		1500 400 720	PTRS 15-4	20615040	
		1600 400 720	PTRS 16-4	20616040	
		1700 400 720	PTRS 17-4	20617040	
		1800 400 720	PTRS 18-4	20618040	
		1900 400 720	PTRS 19-4	20619040	

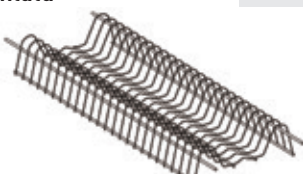
	Διαστάσεις	Μοντέλο	Κωδικός	Τιμή €
	Dimensions	Model	Code	Price €
	(M x B x Y mm)			
<b>Σχάρα για πιάτα</b> Plate grill	750 255 80	SXP 750	29907525	
				

**600**

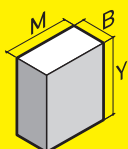

**Με ανοιγόμενες πόρτες**  
With hinged doors



Διαστάσεις Dimensions (M x B mm)	Μοντέλο Model	Κωδικός Code	Τιμή € Price €	Μοντέλο Model	Κωδικός Code	Τιμή € Price €	Μοντέλο Model	Κωδικός Code	Τιμή € Price €
	ΥΨΟΣ - HEIGHT: 1700 mm			ΥΨΟΣ - HEIGHT: 1800 mm			ΥΨΟΣ - HEIGHT: 2000 mm		
600 600	NTSA17 6-6	05017066		NTSA18 6-6	05018066		NTSA20 6-6	05020066	
700 600	NTSA17 7-6	05017076		NTSA18 7-6	05018076		NTSA20 7-6	05020076	
800 600	NTSA17 8-6	05017086		NTSA18 8-6	05018086		NTSA20 8-6	05020086	
900 600	NTSA17 9-6	05017096		NTSA18 9-6	05018096		NTSA20 9-6	05020096	
1000 600	NTSA17 10-6	05017106		NTSA18 10-6	05018106		NTSA20 10-6	05020106	
1100 600	NTSA17 11-6	05017116		NTSA18 11-6	05018116		NTSA20 11-6	05020116	

**600**

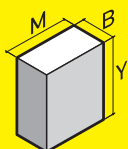

**Με συρόμενες πόρτες**  
With sliding doors



Διαστάσεις Dimensions (M x B mm)	Μοντέλο Model	Κωδικός Code	Τιμή € Price €	Μοντέλο Model	Κωδικός Code	Τιμή € Price €	Μοντέλο Model	Κωδικός Code	Τιμή € Price €
	ΥΨΟΣ - HEIGHT: 1700 mm			ΥΨΟΣ - HEIGHT: 1800 mm			ΥΨΟΣ - HEIGHT: 2000 mm		
1000 600	NTSS17 10-6	06017106		NTSS18 10-6	06018106		NTSS20 10-6	06020106	
1100 600	NTSS17 11-6	06017116		NTSS18 11-6	06018116		NTSS20 11-6	06020116	
1200 600	NTSS17 12-6	06017126		NTSS18 12-6	06018126		NTSS20 12-6	06020126	
1300 600	NTSS17 13-6	06017136		NTSS18 13-6	06018136		NTSS20 13-6	06020136	
1400 600	NTSS17 14-6	06017146		NTSS18 14-6	06018146		NTSS20 14-6	06020146	
1500 600	NTSS17 15-6	06017156		NTSS18 15-6	06018156		NTSS20 15-6	06020156	
1600 600	NTSS17 16-6	06017166		NTSS18 16-6	06018166		NTSS20 16-6	06020166	
1700 600	NTSS17 17-6	06017176		NTSS18 17-6	06018176		NTSS20 17-6	06020176	
1800 600	NTSS17 18-6	06017186		NTSS18 18-6	06018186		NTSS20 18-6	06020186	

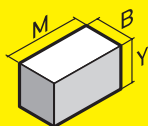

**Διαστάσεις  
Dimensions**  
(M x B x Y mm)

**Μοντέλο  
Model**

**Κωδικός  
Code**

**Τιμή €  
Price €**

**Κλειδαριά**  
Lock

LCK

80000000



**700**

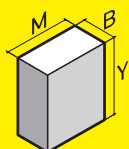

Με ανοιγόμενες πόρτες  
With hinged doors



Διαστάσεις Dimensions (M x B mm)	Μοντέλο Model	Κωδικός Code	Τιμή € Price €	Μοντέλο Model	Κωδικός Code	Τιμή € Price €	Μοντέλο Model	Κωδικός Code	Τιμή € Price €
	ΥΨΟΣ - HEIGHT: 1700 mm			ΥΨΟΣ - HEIGHT: 1800 mm			ΥΨΟΣ - HEIGHT: 2000 mm		
600 700	NTSA17 6-7	05017067		NTSA18 6-7	05018067		NTSA20 6-7	05020067	
700 700	NTSA17 7-7	05017077		NTSA18 7-7	05018077		NTSA20 7-7	05020077	
800 700	NTSA17 8-7	05017087		NTSA18 8-7	05018087		NTSA20 8-7	05020087	
900 700	NTSA17 9-7	05017097		NTSA18 9-7	05018097		NTSA20 9-7	05020097	
1000 700	NTSA17 10-7	05017107		NTSA18 10-7	05018107		NTSA20 10-7	05020107	
1100 700	NTSA17 11-7	05017117		NTSA18 11-7	05018117		NTSA20 11-7	05020117	

**700**

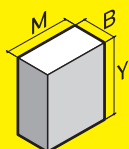

Με συρόμενες πόρτες  
With sliding doors



Διαστάσεις Dimensions (M x B mm)	Μοντέλο Model	Κωδικός Code	Τιμή € Price €	Μοντέλο Model	Κωδικός Code	Τιμή € Price €	Μοντέλο Model	Κωδικός Code	Τιμή € Price €
	ΥΨΟΣ - HEIGHT: 1700 mm			ΥΨΟΣ - HEIGHT: 1800 mm			ΥΨΟΣ - HEIGHT: 2000 mm		
1000 700	NTSS17 10-7	06017107		NTSS18 10-7	06018107	809,00	NTSS20 10-7	06020107	
1100 700	NTSS17 11-7	06017117		NTSS18 11-7	06018117	852,00	NTSS20 11-7	06020117	
1200 700	NTSS17 12-7	06017127		NTSS18 12-7	06018127	892,00	NTSS20 12-7	06020127	
1300 700	NTSS17 13-7	06017137		NTSS18 13-7	06018137	954,00	NTSS20 13-7	06020137	
1400 700	NTSS17 14-7	06017147		NTSS18 14-7	06018147	1010,00	NTSS20 14-7	06020147	
1500 700	NTSS17 15-7	06017157		NTSS18 15-7	06018157	1142,00	NTSS20 15-7	06020157	
1600 700	NTSS17 16-7	06017167		NTSS18 16-7	06018167	1274,00	NTSS20 16-7	06020167	
1700 700	NTSS17 17-7	06017177		NTSS18 17-7	06018177	1405,00	NTSS20 17-7	06020177	
1800 700	NTSS17 18-7	06017187		NTSS18 18-7	06018187	1535,00	NTSS20 18-7	06020187	

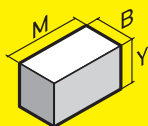

Διαστάσεις  
Dimensions  
(M x B x Y mm)

Μοντέλο  
Model

Κωδικός  
Code

Τιμή €  
Price €

Κλειδαριά  
Lock

LCK

80000000



**400**

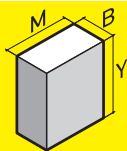

**Διαστάσεις**  
**Dimensions**

(M x B x Y mm)

**Ραφιέρα 4 επιπέδων**  
4 shelves unit

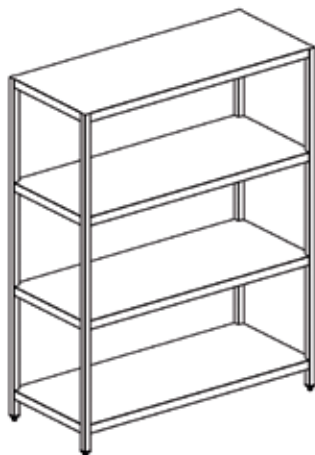

600	400
700	400
800	400
900	400
1000	400
1100	400
1200	400
1300	400
1400	400
1500	400
1600	400
1700	400
1800	400

**ΥΨΟΣ - HEIGHT: 1800 mm**

Μοντέλο Model	Κωδικός Code	Τιμή € Price €
RAF18 6-4	21018064	
RAF18 7-4	21018074	
RAF18 8-4	21018084	
RAF18 9-4	21018094	
RAF18 10-4	21018104	
RAF18 11-4	21018114	
RAF18 12-4	21018124	
RAF18 13-4	21018134	
RAF18 14-4	21018144	
RAF18 15-4	21018154	
RAF18 16-4	21018164	
RAF18 17-4	21018174	
RAF18 18-4	21018184	

**500**

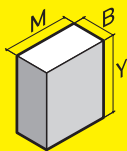

**Διαστάσεις**  
**Dimensions**

(M x B x Y mm)

**Ραφιέρα 4 επιπέδων**  
4 shelves unit

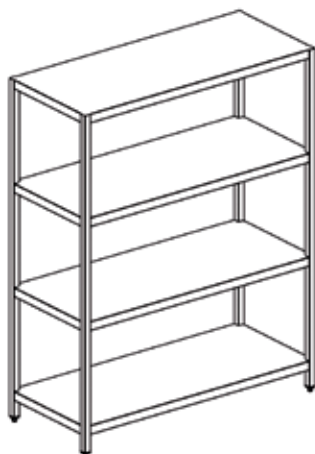

600	500
700	500
800	500
900	500
1000	500
1100	500
1200	500
1300	500
1400	500
1500	500
1600	500
1700	500
1800	500

**ΥΨΟΣ - HEIGHT: 1800 mm**

Μοντέλο Model	Κωδικός Code	Τιμή € Price €
RAF18 6-5	21018065	
RAF18 7-5	21018075	
RAF18 8-5	21018085	
RAF18 9-5	21018095	
RAF18 10-5	21018105	
RAF18 11-5	21018115	
RAF18 12-5	21018125	
RAF18 13-5	21018135	
RAF18 14-5	21018145	
RAF18 15-5	21018155	
RAF18 16-5	21018165	
RAF18 17-5	21018175	
RAF18 18-5	21018185	

**600**

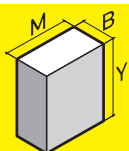

**Διαστάσεις**  
**Dimensions**

(M x B x Y mm)

**Ραφιέρα 4 επιπέδων**  
4 shelves unit

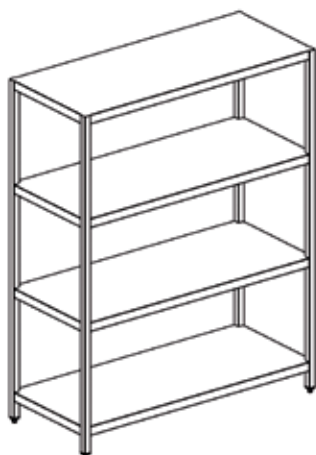

**ΥΨΟΣ - HEIGHT: 1800 mm**

Διαστάσεις Dimensions (M x B x Y mm)		Μοντέλο Model	Κωδικός Code	Τιμή € Price €
600	600	RAF18 6-6	21018066	
700	600	RAF18 7-6	21018076	
800	600	RAF18 8-6	21018086	
900	600	RAF18 9-6	21018096	
1000	600	RAF18 10-6	21018106	
1100	600	RAF18 11-6	21018116	
1200	600	RAF18 12-6	21018126	
1300	600	RAF18 13-6	21018136	
1400	600	RAF18 14-6	21018146	
1500	600	RAF18 15-6	21018156	
1600	600	RAF18 16-6	21018166	
1700	600	RAF18 17-6	21018176	
1800	600	RAF18 18-6	21018186	



**600**

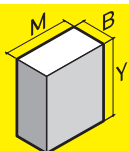

**Διαστάσεις**  
**Dimensions**

(M x B x Y mm)

**Διάτρητη ραφιέρα**  
**4 επιπέδων**  
Perforated 4 shelves unit

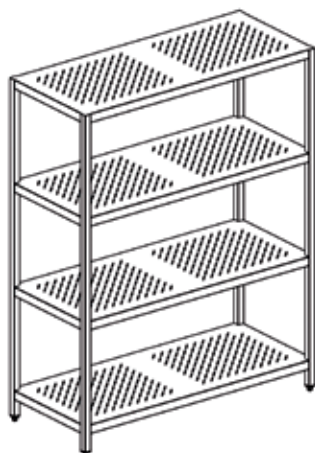

**ΥΨΟΣ - HEIGHT: 1800 mm**

Διαστάσεις Dimensions (M x B x Y mm)		Μοντέλο Model	Κωδικός Code	Τιμή € Price €
600	600	RAF18D 6-6	22018066	
700	600	RAF18D 7-6	22018076	
800	600	RAF18D 8-6	22018086	
900	600	RAF18D 9-6	22018096	
1000	600	RAF18D 10-6	22018106	
1100	600	RAF18D 11-6	22018116	
1200	600	RAF18D 12-6	22018126	
1300	600	RAF18D 13-6	22018136	
1400	600	RAF18D 14-6	22018146	
1500	600	RAF18D 15-6	22018156	
1600	600	RAF18D 16-6	22018166	
1700	600	RAF18D 17-6	22018176	
1800	600	RAF18D 18-6	22018186	

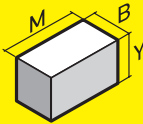
790		Διαστάσεις Dimensions	Γούρνα Sink	Μοντέλο Model	Κωδικός Code	Τιμή € Price €
		(M x B x Y mm)	(M x B mm)			
<b>Δεξιά - Right</b>						
		1200 790 860	500 x 400	PLEISR 12-7	36012079	
		1400 790 860	500 x 400	PLEISR 14-7	36014079	
		1500 790 860	500 x 400	PLEISR 15-7	36015079	
		1600 790 860	500 x 400	PLEISR 16-7	36016079	
		1800 790 860	500 x 400	PLEISR 18-7	36018079	
		2000 790 860	500 x 400	PLEISR 20-7	36020079	
<b>Αριστερά - Left</b>						
		1200 790 860	500 x 400	PLEISL 12-7	36112079	
		1400 790 860	500 x 400	PLEISL 14-7	36114079	
		1500 790 860	500 x 400	PLEISL 15-7	36115079	
		1600 790 860	500 x 400	PLEISL 16-7	36116079	
		1800 790 860	500 x 400	PLEISL 18-7	36118079	
		2000 790 860	500 x 400	PLEISL 20-7	36120079	

Πλυντήριο εισόδου με γούρνα, πανωσήκωμα και ράφι  
Pre-wash table with sink, upstand and shelf

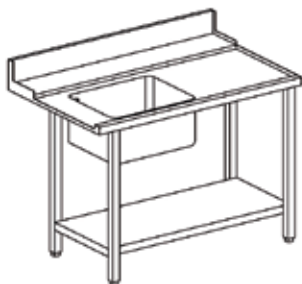

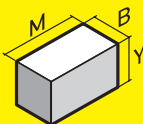
790		Διαστάσεις Dimensions	Γούρνα Sink	Μοντέλο Model	Κωδικός Code	Τιμή € Price €
		(M x B x Y mm)	(M x B mm)			
<b>Δεξιά - Right</b>						
		1400 790 860	500 x 400	PLEISKR 14-7	36214079	
		1500 790 860	500 x 400	PLEISKR 15-7	36215079	
		1600 790 860	500 x 400	PLEISKR 16-7	36216079	
		1800 790 860	500 x 400	PLEISKR 18-7	36218079	
		2000 790 860	500 x 400	PLEISKR 20-7	36220079	
<b>Αριστερά - Left</b>						
		1400 790 860	500 x 400	PLEISKL 14-7	36314079	
		1500 790 860	500 x 400	PLEISKL 15-7	36315079	
		1600 790 860	500 x 400	PLEISKL 16-7	36316079	
		1800 790 860	500 x 400	PLEISKL 17-7	36318079	
		2000 790 860	500 x 400	PLEISKL 20-7	36320079	

Πλυντήριο εισόδου με γούρνα, πανωσήκωμα και χώρο ακαθάρτων  
Sorting table with sink, upstand and frame

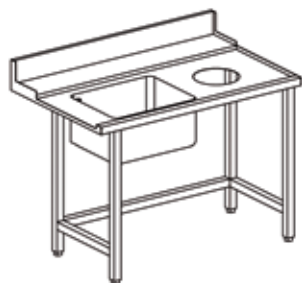

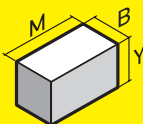



790		Διαστάσεις Dimensions	Γούρνα Sink	Μοντέλο Model	Κωδικός Code	Τιμή € Price €
		(M x B x Y mm)	(M x B mm)			
<b>Δεξιά - Right</b>						
		1400 790 860	500 x 400	PLEISRKR 14-7	36414079	
		1500 790 860	500 x 400	PLEISRKR 15-7	36415079	
		1600 790 860	500 x 400	PLEISRKR 16-7	36416079	
		1800 790 860	500 x 400	PLEISRKR 18-7	36418079	
		2000 790 860	500 x 400	PLEISRKR 20-7	36420079	
<b>Αριστερά - Left</b>						
		1400 790 860	500 x 400	PLEISRKL 14-7	36514079	
		1500 790 860	500 x 400	PLEISRKL 15-7	36515079	
		1600 790 860	500 x 400	PLEISRKL 16-7	36516079	
		1800 790 860	500 x 400	PLEISRKL 18-7	36518079	
		2000 790 860	500 x 400	PLEISRKL 20-7	36520079	

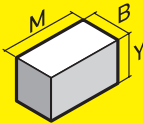

Πλυντήριο εισόδου με γούρνα, πανωσήκωμα, ράφι και χώρο ακαθάρτων  
Sorting table with sink, upstand and shelf



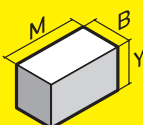



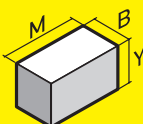

660		Διαστάσεις	Μοντέλο	Κωδικός	Τιμή €
		Dimensions			
		(M x B x Y mm)			
<b>Τραπέζι εξόδου με ράουλα</b> Sorting table for baskets with conveyor rollers 		600 660 860	LPLRA 6-6	37506066	
		1100 660 860	LPLRA 11-6	37511066	
		1600 660 860	LPLRA 16-6	37516066	

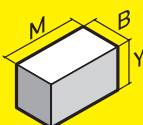
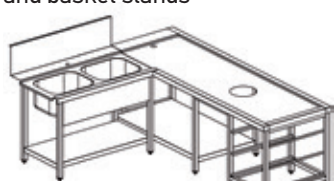
700		Διαστάσεις	Μοντέλο	Κωδικός	Τιμή €
		Dimensions			
		(M x B x Y mm)			
<b>Τραπέζι παραλαβής</b> <b>ακαθάρτων σε σκελετό</b> Pot sorting table in frame 		1200 700 860	PAK 12-7	37012070	
		1600 700 860	PAK 16-7	37016070	
		1800 700 860	PAK 18-7	37018070	

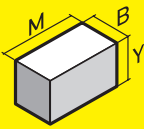

700		Διαστάσεις	Μοντέλο	Κωδικός	Τιμή €
		Dimensions			
		(M x B x Y mm)			
<b>Τραπέζι παραλαβής</b> <b>ακαθάρτων σε σκελετό και ράφι</b> Pot sorting table with shelf 		1200 700 860	PAKR 12-7	37112070	
		1600 700 860	PAKR 16-7	37116070	
		1800 700 860	PAKR 18-7	37118070	

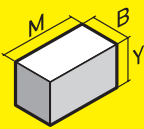

2140		Διαστάσεις	Χωρητικότητα	Μοντέλο	Κωδικός	Τιμή €
		Dimensions				
		(M x B x Y mm)				
<b>Σύστημα πλαινό πλυντηρίου</b> <b>παραλαβής ακαθάρτων, ράφι</b> <b>και θέσεις για μπασκέτες</b> Sorting table with sinks, pot sorting table with shelf and basket stands 		2200 2140 860	3 BAS	PAK+PL 22-21	37222021	
		2850 2140 860	3 BAS	PAK+PL 28-21	37228521	

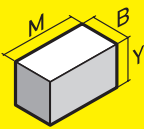

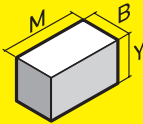
450		Διαστάσεις Dimensions	Μοντέλο Model	Κωδικός Code	Τιμή € Price €
		(M x B x Y mm)			
Ράφι μπασκέτας επιτραπέζιο μονό 1-tier overshef		1200 450 550	REPM 12-3	03012033	
		1600 450 550	REPM 16-3	03016033	
		1800 450 550	REPM 18-3	03018033	

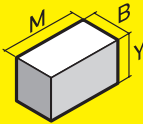

550		Διαστάσεις Dimensions	Μοντέλο Model	Κωδικός Code	Τιμή € Price €
		(M x B x Y mm)			
Ράφι μπασκέτας επιτραπέζιο διπλό 2-tier overshef		1200 550 550	REPB 12-5	05012055	
		1600 550 550	REPB 16-5	05016055	
		1800 550 550	REPB 18-5	05018055	

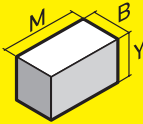

	Διαστάσεις Dimensions	Χωρητικότητα Capacity	Μοντέλο Model	Κωδικός Code	Τιμή € Price €
	(M x B x Y mm)				
Βάση πλυντηρίου με 2 θέσεις για μπασκέτες Table with 2-tier basket storage - washing unit mount	500 500 550	2 BAS	VPL 5-5	37350050	
	600 600 550	2 BAS	VPL 6-6	37360060	

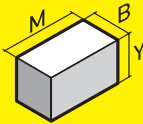

	<b>Διαστάσεις Dimensions</b>  (M x B x Y mm)	<b>Θέσεις GN</b>	<b>Μοντέλο Model</b>	<b>Κωδικός Code</b>	<b>Τιμή € Price €</b>
<b>Τροχήλατο με επιφάνεια &amp; θέσεις γαστρονόμου με κενό 7,5 εκ.</b> Trolley with table surface & gastro-norm slides -7,5 cm slide to slide	400 540 860	8 x 1/1 GN	TRL11GN8 4-5	42004054	
	600 650 860	8 x 2/1 GN	TRL21GN8 6-6	42006065	
					

	<b>Διαστάσεις Dimensions</b>  (M x B x Y mm)	<b>Θέσεις GN</b>	<b>Μοντέλο Model</b>	<b>Κωδικός Code</b>	<b>Τιμή € Price €</b>
<b>Τροχήλατο με θέσεις γαστρονόμου με κενό 7,5 εκ.</b> Trolley with gastro-norm slides -7,5 cm slide to slide	400 540 1620	19 x 1/1 GN	TRL11GN19 4-5	42104054	
	600 650 1620	19 x 2/1 GN	TRL21GN19 6-6	42106065	
					

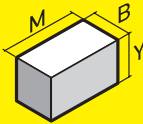
	<b>Διαστάσεις Dimensions</b>  (M x B x Y mm)	<b>Θέσεις GN</b>	<b>Μοντέλο Model</b>	<b>Κωδικός Code</b>	<b>Τιμή € Price €</b>
<b>Τροχήλατο με επιφάνεια και θέσεις ταψιού με κενό 7,5 εκ.</b> Trolley with table surface & baking can slides -7,5 cm slide to slide	470 610 860	9 x 6040 can	TRL60409 4-6	42204761	
					

	<b>Διαστάσεις</b> <b>Dimensions</b> (M x B x Y mm)	<b>Θέσεις</b> <b>GN</b>	<b>Μοντέλο</b> <b>Model</b>	<b>Κωδικός</b> <b>Code</b>	<b>Τιμή €</b> <b>Price €</b>
<p><b>Τροχήλατο με θέσεις ταψιού με κενό 7,5 εκ.</b> Trolley with baking can slides -7,5 cm slide to slide</p> 	<p>470 610 1620</p>	<p>19 x 6040 can</p>	<p>TRL604019 4-6</p>	<p>42304761</p>	

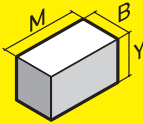
	<b>Διαστάσεις</b> <b>Dimensions</b> (M x B x Y mm)	<b>Θέσεις</b> <b>GN</b>	<b>Μοντέλο</b> <b>Model</b>	<b>Κωδικός</b> <b>Code</b>	<b>Τιμή €</b> <b>Price €</b>
<p><b>Τροχήλατο με επιφάνεια και θέσεις μπασκέτας με κενό 22 εκ.</b> Trolley with table surface and basket slides -22 cm slide to slide</p> 	<p>570 570 860</p>	<p>3 x BAS</p>	<p>TRLBAS3 5-5</p>	<p>42405757</p>	

	<b>Διαστάσεις</b> <b>Dimensions</b> (M x B x Y mm)	<b>Θέσεις</b> <b>GN</b>	<b>Μοντέλο</b> <b>Model</b>	<b>Κωδικός</b> <b>Code</b>	<b>Τιμή €</b> <b>Price €</b>
<p><b>Τροχήλατο με θέσεις μπασκέτας με κενό 22 εκ.</b> Trolley with basket slides -22 cm slide to slide</p> 	<p>570 570 1730</p>	<p>7 x BAS</p>	<p>TRLBAS7 5-5</p>	<p>42505757</p>	

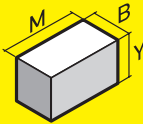
	<b>Διαστάσεις</b> <b>Dimensions</b>  (M x B x Y mm)	<b>Μοντέλο</b> <b>Model</b>	<b>Κωδικός</b> <b>Code</b>	<b>Τιμή €</b> <b>Price €</b>
<b>Αποθήκη πάγου</b> Ice storage unit	592 800 1045	APA 5-8	45005980	
	791 800 1045	APA 7-8	45007980	
	794 820 1274	APA 8-8	45007982	
	1255 800 1045	APA 12-9	45012090	
	1350 800 1045	APA 13-9	45013090	
	1680 1000 1220	APA 16-10	45016810	

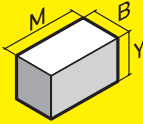

<b>670</b> 	<b>Διαστάσεις</b> <b>Dimensions</b>  (M x B x Y mm)	<b>Μοντέλο</b> <b>Model</b>	<b>Κωδικός</b> <b>Code</b>	<b>Τιμή €</b> <b>Price €</b>
<b>Μονάδα αποθήκευσης</b> <b>άρτου με συρόμενο ράφι</b> Bread storage unit with drawing shelf	700 670 1490	PSM 7-6	45570067	

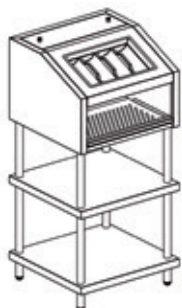

**Τραπέζι εργασίας με 3 αμάρια & 3 συρτάρια τροχήλατα**  
Work table with 3 hoppers & 3-drawer unit on wheels

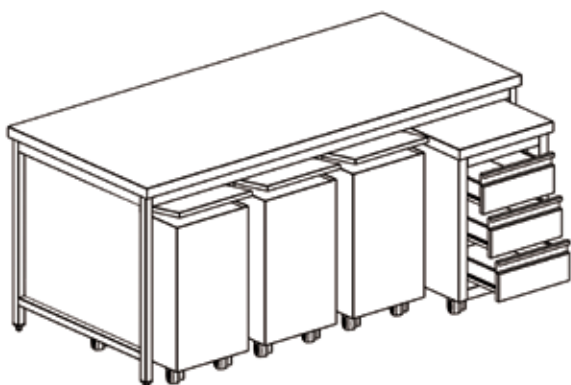

Διαστάσεις - Dimensions	2000 900 900
Μοντέλο - Model	ZTR3A3S 20-9
Κωδικός - Code	60120090
Τιμή € - Price €	-

**Ερμάριο με συρόμενες πόρτες & συρταριέρα**  
Cupboard with sliding doors & drawer unit

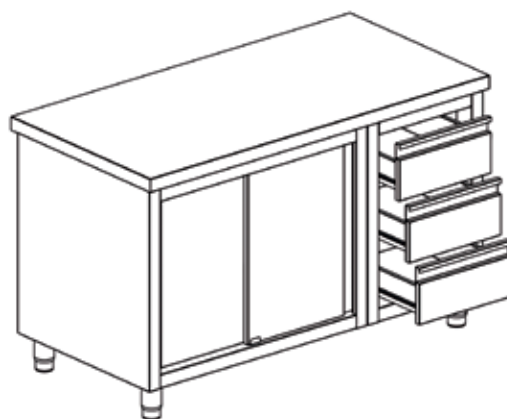

Διαστάσεις - Dimensions	2200 900 900
Μοντέλο - Model	ZSY3S 22-9
Κωδικός - Code	60222090
Τιμή € - Price €	-

**Ερμάριο με συρόμενες πόρτες**  
Cupboard with sliding doors

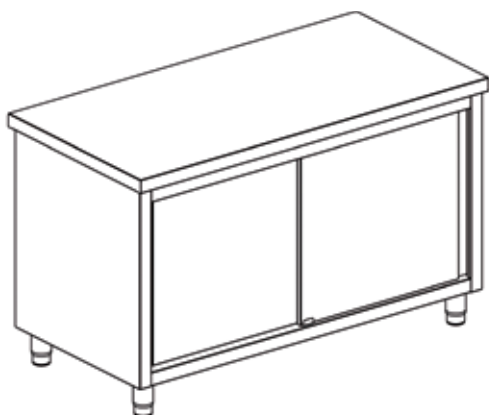

Διαστάσεις - Dimensions	2000 900 900
Μοντέλο - Model	ZSYM 20-9
Κωδικός - Code	60320090
Τιμή € - Price €	-

**Βάση σκευών τροχήλατη**  
Pot trolley

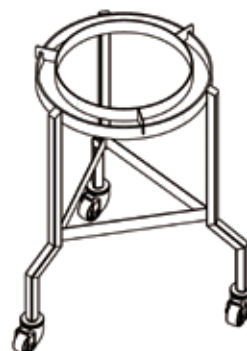

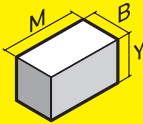
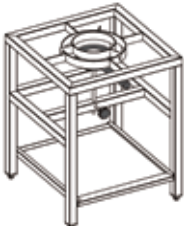

Διαστάσεις - Dimensions	660 660 770
Μοντέλο - Model	ZTRLSKE 6-6
Κωδικός - Code	60506666
Τιμή € - Price €	-

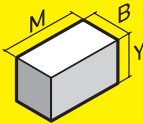
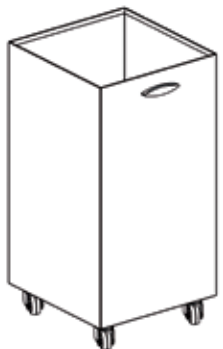

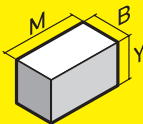
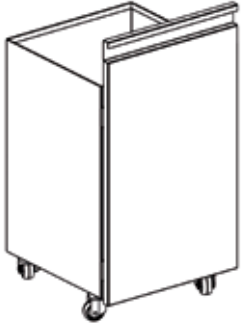
600 	Διαστάσεις Dimensions (M x B x Y mm)	KW	Μοντέλο Model	Κωδικός Code	Τιμή € Price €
<b>Εστία υγραερίου χαμηλής πίεσης</b> LPG burner low pressure 	600 600 750	15	ZLPGB 6-6	60406060	-
	1100 600 750	15 / 15	ZLPGB 11-6	60411060	-
	1300 600 750	15 / 15 / 10	ZLPGB 13-6	60413060	-

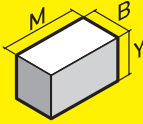
400 	Διαστάσεις Dimensions	Μοντέλο Model	Κωδικός Code	Τιμή € Price €
	(M x B x Y mm)			
Κάδος τροχήλατος Bin on wheels	340 400 760	KADEC 34-40	50003440	
	380 400 760	KADEC 38-40	50003840	
	420 400 760	KADEC 42-40	50004240	
				

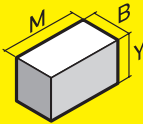

400 	Διαστάσεις Dimensions	Μοντέλο Model	Κωδικός Code	Τιμή € Price €
	(M x B x Y mm)			
Κάδος τροχήλατος premium Bin on wheels premium	340 400 760	KADPR 34-40	50103440	
	380 400 760	KADPR 38-40	50103840	
	420 400 760	KADPR 42-40	50104240	
	460 400 760	KADPR 46-40	50104640	
	500 400 760	KADPR 50-40	50105040	
				

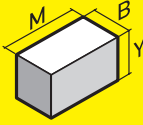
400 	Διαστάσεις Dimensions	STANDARD			PREMIUM		
		Μοντέλο Model	Κωδικός Code	Τιμή € Price €	Μοντέλο Model	Κωδικός Code	Τιμή € Price €
Λάστιχο παραλαβής ακαθάρτων Rubber for sorting table		PLS-205	50200000		PLS-255	50300000	

	<b>Διαστάσεις</b> <b>Dimensions</b> (M x B mm)	<b>Μοντέλο</b> <b>Model</b>	<b>Κωδικός</b> <b>Code</b>	<b>Τιμή €</b> <b>Price €</b>
<b>Γούρνα</b> Sink 	405 x 405	LTZ 4-4	50540540	
	405 x 505	LTZ 4-5	50540550	
	505 x 505	LTZ 5-5	50550550	

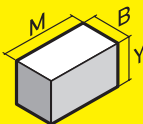
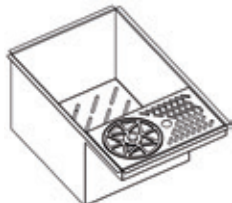
<b>140</b> 	<b>Διαστάσεις</b> <b>Dimensions</b> (M x B x Y mm)	<b>Μοντέλο</b> <b>Model</b>	<b>Κωδικός</b> <b>Code</b>	<b>Τιμή €</b> <b>Price €</b>
<b>Χωνευτό ρίνσερ</b> Counter top glass rinser build-in 	300 140 26	RINEXO 3-1	35230014	

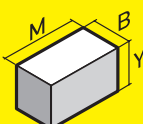
	<b>Διαστάσεις</b> <b>Dimensions</b> (M x B mm)	<b>Μοντέλο</b> <b>Model</b>	<b>Κωδικός</b> <b>Code</b>	<b>Τιμή €</b> <b>Price €</b>
<b>Γούρνα με χωνευτό ρίνσερ</b> Sink with counter top glass rinser 	250 x 405	RNSG 2-4	50602540	
	350 x 500	RNSG 3-5	50603550	

	<b>Διαστάσεις</b> <b>Dimensions</b> (M x B mm)	<b>Μοντέλο</b> <b>Model</b>	<b>Κωδικός</b> <b>Code</b>	<b>Τιμή €</b> <b>Price €</b>
<b>Ταψί αλουμινίου</b> Aluminum tray 	440 x 320	TAL 44-32	51004432	
	600 x 400	TAL 60-40	51006040	
	600 x 400 x 10	TAL 60-41	51006041	
	600 x 400 x 20	TAL 60-42	51006042	
	600 x 400 x 30	TAL 60-43	51006043	
	600 x 400 x 40	TAL 60-44	51006044	
	600 x 400 x 50	TAL 60-45	51006045	



Έδρα: Δημητρακοπούλου 2 & Αχιλλέως 100, Παλαιό Φάληρο  
Τηλέφωνα Επικοινωνίας: 215 5459041 – 215 5560931  
Ιστότοποι: [www.exoplismosonline.gr](http://www.exoplismosonline.gr) | [www.secondhandinox.gr](http://www.secondhandinox.gr)  
@ Email: [exoplismosmde@gmail.com](mailto:exoplismosmde@gmail.com) | [sales@exoplismosmde.gr](mailto:sales@exoplismosmde.gr)

EXOPLISMOS  
online Εξοπλισμός Μαζικής Εστίασης  
[www.exoplismosonline.gr](http://www.exoplismosonline.gr)